

tahuma

Elenco Componenti
Components List

2023

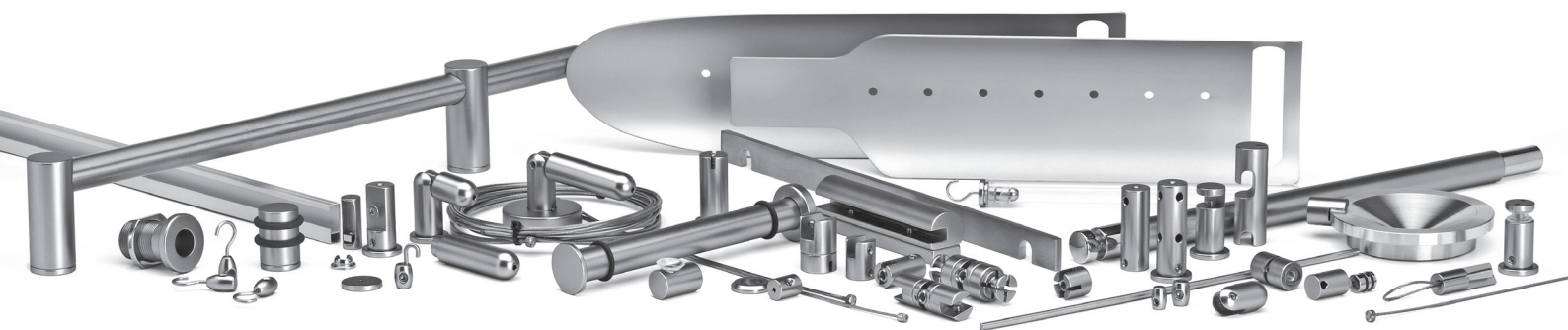



Progettare lo spazio nel segno
del design in 3 fasi.
Designing space in the name
of design in 3 steps.

Scegli il sistema portante più idoneo:
Choose the adequate supporting system:

A

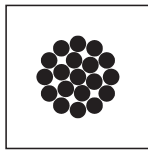

→2 01

Cavo
Cable

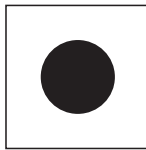
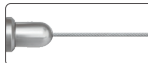

→3 11

Barra
Bar

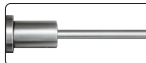

→3 09

Tubo
Tube

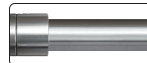

Scegli i punti di ancoraggio:
Choose the anchor points:

B

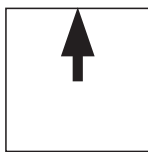

Soffitto
Ceiling

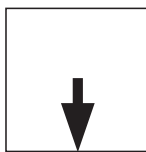

Pavimento
Floor

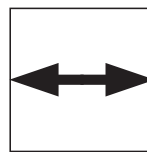

Spalle
Side-walls

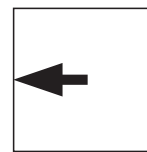

Parete
Wall

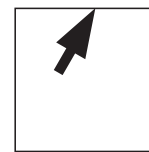

Parete-soffitto inclinato
Sloped wall-ceiling

Seleziona i componenti più adatti consultando l'elenco dei componenti
Select the most suitable components by consulting the components list

C

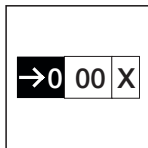

Identificativo prodotto
Product reference mark
Produktidentifikation
Identification du produit

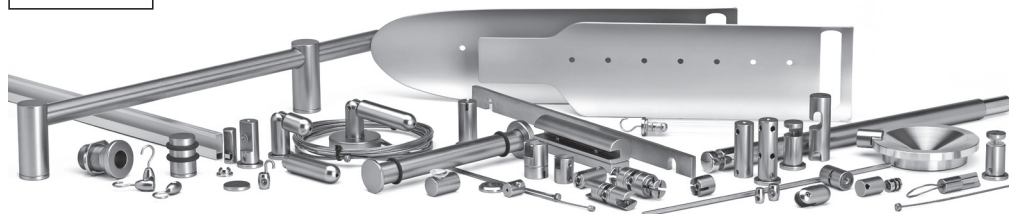

Nota Bene

Attention



Verificare le caratteristiche del prodotto e le condizioni di utilizzo alla sezione tecnica.
Check product information and using instructions on technical datasheets.
Produkteigenschaften und Gebrauchsbedingungen im Technischen Datenblätter prüfen.
Vérifier les caractéristiques du produit et ses conditions d'utilisation dans les fiches techniques.

Prima di utilizzare qualunque tipo di fissaggio consultare i carichi ammessi dal produttore dei fissaggi.
Before using any type of fastenings, please consult the manufacturer for their loads capacity.

Viti e tasselli non sono forniti volutamente: poiché i soffitti, le pareti e i pavimenti possono essere di materiali diversi, rivolgersi ad un rivenditore specializzato descrivendo le caratteristiche del sistema da fissare e delle superfici su cui ancorarsi, che devono essere solide e in grado di sostenere pesi e trazioni, indicando in particolar modo il peso a massimo carico.

Il fissaggio dev'essere effettuato a regola d'arte da persone qualificate.
Screws and anchors are deliberately not included: since ceilings, walls and floors may be made of different materials, please consult a qualified tradesperson for the right choice, describing the characteristics of the system to be fixed - in particular the weight at maximum load of the system to be applied - and the wall type, that must be solid and capable to sustain weights and tractions.
Fixing to the wall must be carried out in a workmanlike manner by qualified personnel.

Officina Colombo Srl non potrà essere ritenuta responsabile dei danni a persone o cose dovuti ad un fissaggio/ancoraggio o montaggio non corretto.
Officina Colombo Srl cannot accept any liability for damage or injury to person or property caused by inadequate fixing, anchorage or assembly.

Verificare periodicamente che tutti i componenti strutturali e di fissaggio siano integri ed in buono stato funzionale.
Regularly ensure that all components of the system are fully tightened and in good conditions as well as the fixings.

I contenuti del presente Catalogo sono tutelati dal diritto d'autore.
E' vietata la riproduzione e l'uso senza l'autorizzazione scritta di Officina Colombo s.r.l.
All the contents of this price list are subject to intellectual property rules.
It is forbidden to copy and use without a written authorization of Officina Colombo s.r.l.

Elenco Componenti

Il presente Elenco dei Componenti è formulato per la scelta dei componenti più adatti per i vostri progetti:

Sistemi a cavo
Sistemi a tubo
Sistemi a barra
Elementi di supporto
Oggettistica
Sistemi espositivi

Le informazioni riportate non sono vincolanti e possono subire variazioni in qualsiasi momento in base alle esigenze di produzione e di qualità. Lo staff Tahuma è a disposizione per ogni necessità o chiarimento tecnico.

I contenuti del presente Elenco dei Componenti sono tutelati dal diritto d'autore. E' vietata la riproduzione e l'uso senza l'autorizzazione scritta di Officina Colombo s.r.l.

Components List

This Components List is formulated for the choiche of the suitable components for your projects:

Cable systems
Tube systems
Bar systems
Supports
Objects
Displaying systems

Information are not binding and may change in any moment according to the needs of production and quality. Tahuma staff is available for every need or technical clarification.

All the contents of this Components List are subject to intellectual property rules. It is forbidden to copy and use without a written authorization of Officina Colombo s.r.l.

Indice

Tenditori
Cavi
Morsetti
Comunicazione
Arredamento
SOLO - MOMA
Oggettistica e complementi
Componenti
Grafiche
Numeri e lettere

Index

Tensioners	→ 1	Pag. 04-08
Cables	→ 2	Pag. 09-10
Clips	→ 3	Pag. 11-26
Communication	→ 4	Pag. 27-32
Furniture	→ 5	Pag. 33-38
SOLO - MOMA	→ 6	Pag. 39-41
Objects and complements	→ 7	Pag. 42-46
Components	→ 9	Pag. 47-51
Graphics	→ 10	Pag. 52
Numbers and letters	→ 11	Pag. 53

NKS = Finitura Nichel satinato

CR = Finitura Cromo

NK = Finitura Nichel



= Portata massima espressa in kg.



= Schermato
(impedisce che le singole coppie di pinze si attraggano reciprocamente)



= Nuovo prodotto



= Nuova versione

Misure espresse in millimetri

Nickel satin finishing

Chrome finishing

Nickel finishing

Maximum capacity in kg.

Screened

(to avoid the single couples to attract each other)

New product

New version

Dimensions in millimeters

1 01 A

Tendicavo a soffitto
Fixed top cable tensioner

Morsetto fissacavi (rif. 307) NON INCLUSO
Foldaway clip (ref. 307) NOT INCLUDED



FC16125U **NKS**

10

8032611951305

FC16126U **CR**

10

8032611951329

1 01 B

Tendicavo a soffitto con rosetta
Fixed top cable tensioner with washer

Morsetto fissacavi (rif. 307) NON INCLUSO
Foldaway clip (ref. 307) NOT INCLUDED

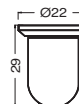

FC16125UR **NKS**

10

8032611950872

FC16126UR **CR**

10

8032611950896

1 02 A

Tendicavo a pavimento
Fixed bottom cable tensioner

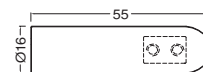

FC16125D **NKS**

10

8032611951343

FC16126D **CR**

10

8032611951367

1 02 B

Tendicavo a pavimento con rosetta
Fixed bottom cable tensioner with washer

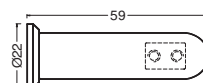

FC16125DR **NKS**

10

8032611950919

FC16126DR **CR**

10

8032611950933

1 03 A

Tendicavo snodato corto
Short swivel cable tensioner



SC165T **NKS**

8

8032611950704

SC166T **CR**

8

8032611950735

1 03 B

Tendicavo snodato corto con rosetta
Short swivel cable tensioner with washer

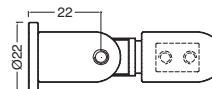

SC165RT **NKS**

8

8032611952265

SC166RT **CR**

8

8032611952296

1 03 C

Tendicavo snodato corto con flangia
Short swivel cable tensioner with flange

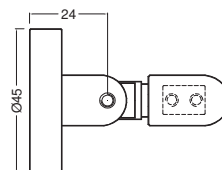

SC165FT **NKS**

2

8032611950643

SC166FT **CR**

2

8032611950674

1 04 A

Tendicavo snodato corto-lungo
Short-long swivel cable tensioner

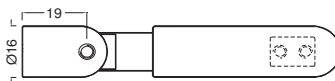

SCL165T NKS

8

8032611951251

SCL166T CR

8

8032611951282

1 04 B

Tendicavo snodato corto-lungo con rosetta
Short-long swivel cable tensioner with washer

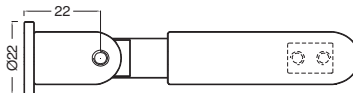

SCL165RT NKS

8

8032611952388

SCL166RT CR

8

8032611952418

1 04 C

Tendicavo snodato corto-lungo con flangia
Short-long swivel cable tensioner with flange

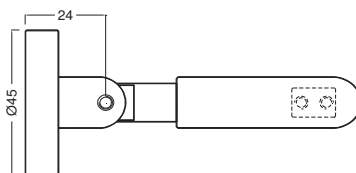

SCL165FT NKS

2

8032611952913

SCL166FT CR

2

8032611952920

1 05 A

Tendicavo snodato lungo-corto
Long-short swivel cable tensioner

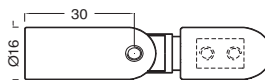

SLC165T NKS

8

8032611950827

SLC166T CR

8

8032611950858

1 05 B

Tendicavo snodato lungo-corto con rosetta
Long-short swivel cable tensioner with washer

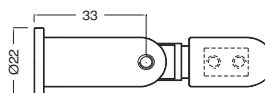

SLC165RT NKS

8

8032611952326

SLC166RT CR

8

8032611952357

1 05 C

Tendicavo snodato lungo-corto con flangia
Long-short swivel cable tensioner with flange

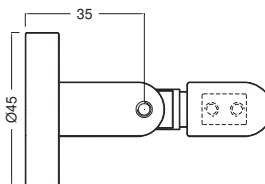

SLC165FT NKS

2

8032611950766

SLC166FT CR

2

8032611950797

1 06 A

Tendicavo snodato lungo
Long swivel cable tensioner

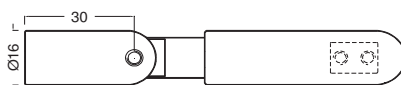

SL165T NKS

8

8032611950582

SL166T CR

8

8032611950612

1 TENDITORI
TENSIONERS

Linea CAVO
CABLE Line

Pz./ CONF.
Pcs. / BOX

PREZZO CAD.
PRICE EACH

CODICE EAN 13
EAN 13 CODE

1 06 B

Tendicavo snodato lungo con rosetta
Long swivel cable tensioner with washer

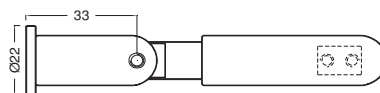

SL165RT	NKS	8	8032611952203
SL166RT	CR	8	8032611952234

1 06 C

Tendicavo snodato lungo con flangia
Long swivel cable tensioner with flange

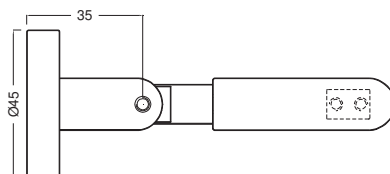

SL165FT	NKS	2	8032611950520
SL166FT	CR	2	8032611950551

1 07

Kit tendicavo verticale
Cable tensioner vertical kit

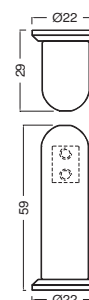

FC165VT	NKS	4	8032611950445
FC166VT	CR	4	8032611950469

1 08

Kit tendicavo orizzontale
Cable tensioner horizontal kit

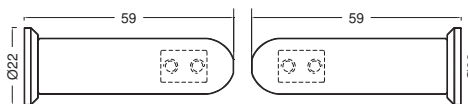

FC165OT	NKS	4	8032611950483
FC166OT	CR	4	8032611950506

1 11 A

Richiede l'esecuzione di una tacca sulla barra
Needs a notch on the barTenditore a soffitto per barra
Fixed top tensioner for bar

FB16125U NKS

10

8032611954788

FB16126U CR

10

8032611954795

1 11 B

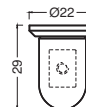
Richiede l'esecuzione di una tacca sulla barra
Needs a notch on the barTenditore a soffitto con rosetta per barra
Fixed top tensioner with washer for bar

FB16125UR NKS

10

8032611954801

FB16126UR CR

10

8032611954818

1 12 A

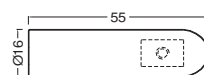
Richiede l'esecuzione di una tacca sulla barra
Needs a notch on the barTenditore a pavimento per barra
Fixed bottom tensioner for bar

FB16125D NKS

10

8032611954825

FB16126D CR

10

8032611954832

1 12 B

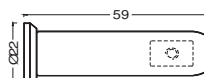
Richiede l'esecuzione di una tacca sulla barra
Needs a notch on the barTenditore a pavimento con rosetta per barra
Fixed bottom tensioner with washer for bar

FB16125DR NKS

10

8032611954849

FB16126DR CR

10

8032611954856

1 13 A

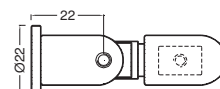
Richiede l'esecuzione di una tacca sulla barra
Needs a notch on the barTenditore snodato corto con rosetta per barra
Short swivel tensioner with washer for bar

BC165RT NKS

8

8032611954863

BC166RT CR

8

8032611954870

1 13 B

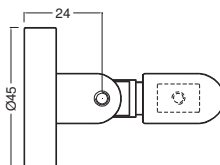
Richiede l'esecuzione di una tacca sulla barra
Needs a notch on the barTenditore snodato corto con flangia per barra
Short swivel tensioner with flange for bar

BC165FT NKS

2

8032611954887

BC166FT CR

2

8032611954894

**1 TENDITORI
TENSIONERS**

**Linea BARRA
BAR Line**

Pz./ CONF.
Pcs. / BOX

PREZZO CAD.
PRICE EACH

CODICE EAN 13
EAN 13 CODE

1 14A

Tenditore snodato corto-lungo con rosetta per barra
Short-long swivel tensioner with washer for bar

Richiede l'esecuzione di una tacca sulla barra
Needs a notch on the bar

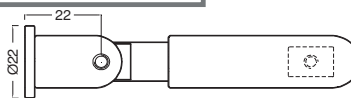

BCL165RT NKS

8

8032611954900

BCL166RT CR

8

8032611954917

1 14B

Tenditore snodato corto-lungo con flangia per barra
Short-long swivel tensioner with flange for bar

Richiede l'esecuzione di una tacca sulla barra
Needs a notch on the bar

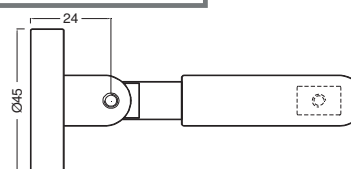

BCL165FT NKS

2

8032611954924

BCL166FT CR

2

8032611954931

1 15A

Tenditore snodato lungo-corto con rosetta per barra
Long-short swivel tensioner with washer for bar

Richiede l'esecuzione di una tacca sulla barra
Needs a notch on the bar

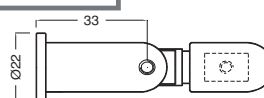

BLC165RT NKS

8

8032611954948

BLC166RT CR

8

8032611954955

1 15B

Tenditore snodato lungo-corto con flangia per barra
Long-short swivel tensioner with flange for bar

Richiede l'esecuzione di una tacca sulla barra
Needs a notch on the bar

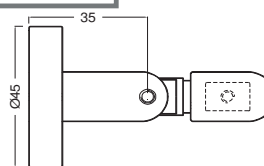

BLC165FT NKS

2

8032611954962

BLC166FT CR

2

8032611954979

1 16A

Tenditore snodato lungo con rosetta per barra
Long swivel tensioner with washer for bar

Richiede l'esecuzione di una tacca sulla barra
Needs a notch on the bar

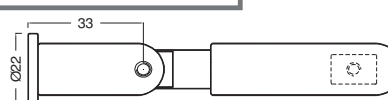

BL165RT NKS

8

8032611954986

BL166RT CR

8

8032611954993

1 16B

Tenditore snodato lungo con flangia per barra
Long swivel tensioner with flange for bar

Richiede l'esecuzione di una tacca sulla barra
Needs a notch on the bar

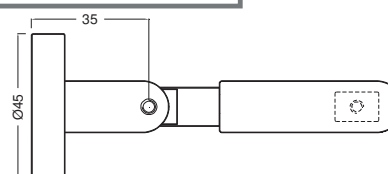

BL165FT NKS

2

8032611955006

BL166FT CR

2

8032611955013

2 00

Cavo Ømm. 2,00 AISI316 a 19 fili su bobina da mt. 100
N.B.: Cavo fornito senza terminale saldato. Utilizzare con morsetto MF1002. Portata limitata

Cable Ø mm. 2,00 AISI316 19 wires on spool of mt.100
N.B.: Cable furnished without welded ending. Use with clip MF1002. Limited capacity



CA200X mt. 100

8032611955860

2 01

Cavo Ømm. 2,00 AISI316 19 fili con cilindro Ø6x3.50 saldato
Cable Ømm. 2,00 AISI316 19 wires with Ø6x3.50 welded cylinder

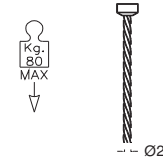

CA20005XIB	mt. 0,50	1	8032611953286
CA20005XI	mt. 0,50	12	8032611953279
CA20010XIB	mt. 1,00	1	8032611951008
CA20010XI	mt. 1,00	12	8032611951015
CA20015XIB	mt. 1,50	1	8032611951022
CA20015XI	mt. 1,50	12	8032611951039
CA20020XIB	mt. 2,00	1	8032611951046
CA20020XI	mt. 2,00	12	8032611951053
CA20025XIB	mt. 2,50	1	8032611951060
CA20025XI	mt. 2,50	12	8032611951077
CA20030XIB	mt. 3,00	1	8032611951084
CA20030XI	mt. 3,00	12	8032611951091
CA20035XIB	mt. 3,50	1	8032611951107
CA20035XI	mt. 3,50	12	8032611951114
CA20040XIB	mt. 4,00	1	8032611951121
CA20040XI	mt. 4,00	12	8032611951138
CA20045XIB	mt. 4,50	1	8032611951145
CA20045XI	mt. 4,50	12	8032611951152
CA20050XIB	mt. 5,00	1	8032611951169
CA20050XI	mt. 5,00	12	8032611951176
CA20060XIB	mt. 6,00	1	8032611953231
CA20060XI	mt. 6,00	12	8032611952586

2 02

Non adatto all'utilizzo con binario 605
Not suitable with rail 605

Cavo Ømm. 1,50 AISI316 49 fili con cilindro Ø5x4.50 pressato per sistema SOLO
Cable Ømm. 1,50 AISI316 49 wires with Ø5x4.50 pressed cylinder for SOLO system

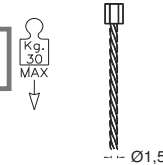

CA15005XIB	mt. 0,50	10	8032611953446
CA15010XIB	mt. 1,00	10	8032611953453
CA15015XIB	mt. 1,50	10	8032611953460
CA15020XIB	mt. 2,00	10	8032611953095

2 03

Adatto all'utilizzo con binario 605
Suitable with rail 605

Cavo Ømm. 1,50 AISI316 49 fili con cilindro Ø6x3.50 saldato per sistema MOMA
Cable Ømm. 1,50 AISI316 49 wires with Ø6x3.50 welded cylinder for MOMA system

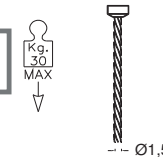

CA15005XMB	mt. 0,50	10	8032611954016
CA15010XMB	mt. 1,00	10	8032611954023
CA15015XMB	mt. 1,50	10	8032611954030
CA15020XMB	mt. 2,00	10	8032611953101
CA15025XMB	mt. 2,50	10	8032611958335
CA15030XMB	mt. 3,00	10	8032611952067

2 CAVI
CABLES

Pz./ CONF.
Pcs. / BOX

PREZZO CAD.
PRICE EACH

CODICE EAN 13
EAN 13 CODE

2 04

Terminale oliva per cavi
Olive ending for cables



MF08205BK **NKS**
MF08206BK **CR**

10
10

8032611953149
8032611953156

2 05

Contrappeso
Counterweight

Morsetto fissacavi incluso
Foldaway clip included

Lunghezza minima del cavo dalla fine del morsetto
Minimum cable length from the end of the clip

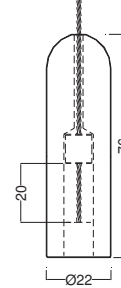

CP225 **NKS**
CP226 **CR**

4
4

8032611953477
8032611953484

3 01

Morsetto di testa Ø16 mm.
Head mounting clip Ø16 mm.

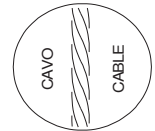

MR16105KT	NKS	20
MR16106KT	CR	20

8032611950148
8032611950209

3 02

Morsetto di testa doppio Ø16 mm.
Double head mounting clip Ø16 mm.

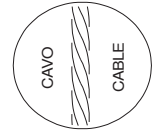
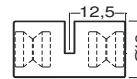

MR16105K2T	NKS	10
MR16106K2T	CR	10

8032611950179
8032611950230

3 03 A

Morsetto orientabile per pannelli mm. 7
Orientable clip for panels mm. 7

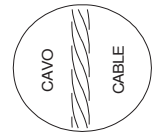
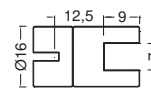

MR16075IT	NKS	20
MR16076IT	CR	20

8032611950025
8032611950056

3 03 B

Morsetto orientabile per pannelli mm. 11
Orientable clip for panels mm. 11

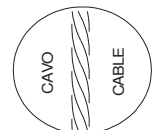
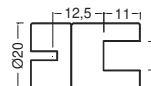

MR20115IT	NKS	20
MR20116IT	CR	20

8032611950261
8032611950292

3 03 C

Morsetto orientabile per pannelli mm. 3
Orientable clip for panels mm. 3

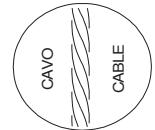
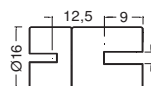

MR16035IT	NKS	20
MR16036IT	CR	20

8032611957253
8032611957260

3 04 A

Morsetto orientabile doppio per pannelli mm. 7
Double orientable clip for panels mm. 7

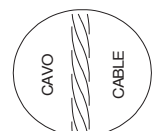
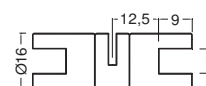

MR16075I2T	NKS	10
MR16076I2T	CR	10

8032611950087
8032611950117

3 04 B

Morsetto orientabile doppio per pannelli mm. 11
Double orientable clip for panels mm. 11

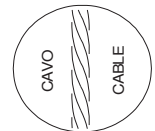

MR20115I2T	NKS	10
MR20116I2T	CR	10

8032611950322
8032611950353

3 04 C

Morsetto orientabile doppio per pannelli mm. 3
Double orientable clip for panels mm. 3

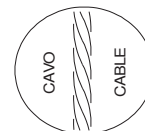
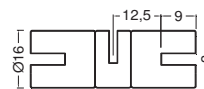

MR16035I2T	NKS	10
MR16036I2T	CR	10

8032611957277
8032611957284

3 05 A

Morsetto a croce cavo-cavo
90° cross clip joint cable-cable

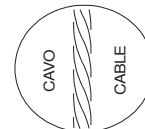

MC16025T	NKS	20
MC16026T	CR	20

8032611950384
8032611950414

3 05 B

Morsetto a croce cavo-barra
90° cross clip joint cable-bar



MB16045T	NKS	10
MB16046T	CR	10

8032611954207
8032611954214

3 06

Kit morsetto per cavo passante
Passing through cable clip kit



MR125PKT	NKS	20
MR126PKT	CR	20

8032611951190
8032611951220

3 07

Morsetto fissacavi a scomparsa
Foldaway clip

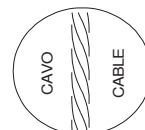
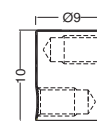

MF1002	NK	20
---------------	-----------	----

8032611951725

3 08 A

Morsetto per tubi arredamento Ø18x1 mm.
Clip for furnishing tubes Ø18x1 mm.

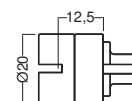

MT20185K	NKS	8
MT20186K	CR	8

8032611953736
8032611953743

3 08 B

Morsetto doppio per tubi arredamento Ø18x1 mm.
Double clip for furnishing tubes Ø18x1 mm.

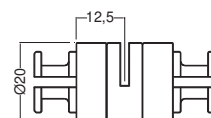

MT20185K2	NKS	4
MT20186K2	CR	4

8032611953750
8032611953767

3 09

Tubo arredo Ø18x1 mm. AISI304 satinato

** realizzabile il taglio a misura

Furnishing tube Ø18x1 mm. AISI304 satin

** customised cut on request



TB180109	mt. 0,10	1	8032611955907
TB180209	mt. 0,20	1	8032611955914
TB180309	mt. 0,30	1	8032611955921
TB180409	mt. 0,40	1	8032611955938
TB180509	mt. 0,50	1	8032611955945
TB180609	mt. 0,60	1	8032611953996
TB180709	mt. 0,70	1	8032611954009
TB180809	mt. 0,80	1	8032611955877
TB180909	mt. 0,90	1	8032611955884
TB181009	mt. 1,00	1	8032611955891
TB181109	mt. 1,10	1	8032611954047
TB181209	mt. 1,20	1	8032611954054
TB181309	mt. 1,30	1	8032611950339
TB181409	mt. 1,40	1	8032611950346
TB181509	mt. 1,50	1	8032611950360
TB181609	mt. 1,60	1	8032611950377
TB181709	mt. 1,70	1	8032611950391
TB181809	mt. 1,80	1	8032611950407
TB181909	mt. 1,90	1	8032611950421
TB182009	mt. 2,00	1	8032611950438
TB182109	mt. 2,10	1	8032611950452
TB182209	mt. 2,20	1	8032611950476
TB182309	mt. 2,30	1	8032611950490
TB182409	mt. 2,40	1	8032611950513
TB182509	mt. 2,50	1	8032611954061
TB182609	mt. 2,60	1	8032611958465
TB182709	mt. 2,70	1	8032611958472
TB182809	mt. 2,80	1	8032611958489
TB182909	mt. 2,90	1	8032611958496
TB183009	mt. 3,00	1	8032611950537

3 09 A

Supporto a parete per tubi Ø18 mm.

Wall clip for tubes Ø18 mm.

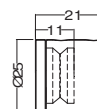

TO25185	NKS	4	8032611954603
TO25186	CR	4	8032611954610

3 09 A2

Supporto a parete per tubi Ø18 mm. x 31 mm.

Wall clip for tubes Ø18 mm. x 31 mm.

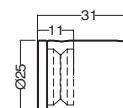

TO25285	NKS	4	8032611958625
TO25286	CR	4	8032611958694



3 09 B

Supporto a soffitto con foro passante per tubi Ø18 mm.

Top clip with passing through hole for tubes Ø18 mm.

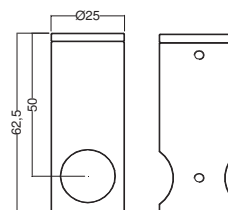

TO25185P	NKS	2	8032611954627
TO25186P	CR	2	8032611954634

3 09 C

Supporto a soffitto con foro cieco per tubi Ø18 mm.
Top clip with blind hole for tubes Ø18 mm.

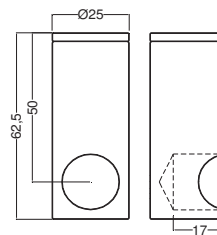

TO25185C	NKS	2	8032611954641
TO25186C	CR	2	8032611954658

3 09 D

Supporto per tubi Ø18 mm. con due fori passanti
Clip for tubes Ø18 mm. with two passing through holes

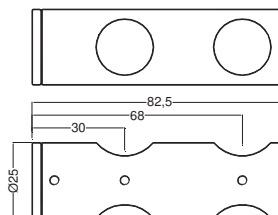

TO25185P2	NKS	2	8032611955082
TO25186P2	CR	2	8032611955099

3 09 E

Supporto per tubi Ø18 mm. con due fori ciechi
Clip for tubes Ø18 mm. with two blind holes

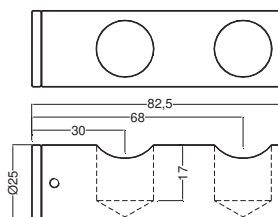

TO25185C2	NKS	2	8032611955976
TO25186C2	CR	2	8032611955983

3 09 F

Tappo per tubi Ø18 mm.
Cap for tubes 18 mm.

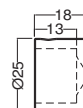

TT25185	NKS	4	8032611955105
TT25186	CR	4	8032611955112

3 09 G

Supporto corto con foro cieco per tubi Ø18 mm.
Short clip with blind hole for tubes Ø18 mm.

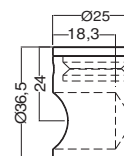

TC25185C	NKS	4	8032611956737
TC25186C	CR	4	8032611956744

3 09 H

Supporto corto con foro passante per tubi Ø18 mm.
Short clip with passing through hole for tubes Ø18 mm.

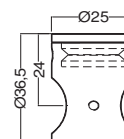

TC25185P	NKS	4	8032611956713
TC25186P	CR	4	8032611956720

3 09 L

Supporto a parete lungo per tubi Ø18 mm.
Long wall clip for tubes Ø18 mm.

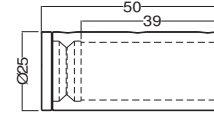

TO25180505 NKS

2

8032611956973

TO25180506 CR

2

8032611956980

3 09 M

Giunto per tubi Ø18 mm. foro passante
Joint for tubes Ø18 mm. passing through hole

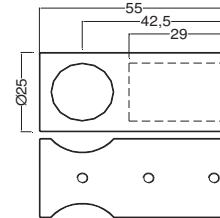

TO25185G NKS

2

8032611957017

TO25186G CR

2

8032611957024

3 09 M2

Giunto per tubi Ø18 mm. foro cieco
Joint for tubes Ø18 mm. blind hole

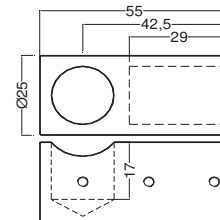

TO25185GC NKS

2

8032611958175

TO25186GC CR

2

8032611958182

3 09 N

Supporto snodato per tubi Ø18 mm.
Swiveled support for tubes Ø18 mm.

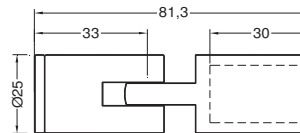

ST25185RT NKS

1

8032611957031

ST25186RT CR

1

8032611957048

3 09 O

Supporto per tubi Ø18 mm. con 1 foro passante
Clip for tubes Ø18 mm. with one passing through hole

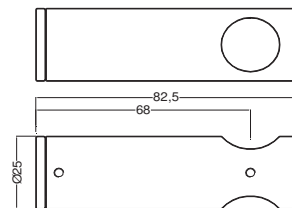

TO25185PL NKS

2

8032611958199

TO25186PL CR

2

8032611958205

3 09 P

Supporto per tubi Ø18 mm. con 1 foro cieco
Clip for tubes Ø18 mm. with one blind hole

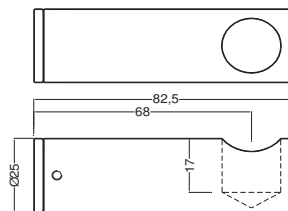

TO25185CL NKS
TO25186CL CR

2
2

8032611958212
8032611958229

3 09 Q

Manicotto reggipiano Ø30 per tubi Ø18 mm.
Ø30 Sleeve for shelves for tubes Ø18 mm.

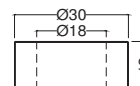

ST30135 NKS
ST30136 CR

4
4

8032611958526
8032611958533

3 09 R

Giunto corto a 90° per tubi Ø18 mm. foro passante
Short 90° passing through joint for tubes Ø18 mm.

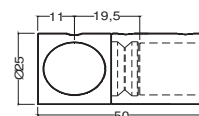

TO25185GM NKS
TO25186GM CR

2
2

8032611958540
8032611958557



3 09 S

Doppio giunto corto a 90° per tubi Ø18 mm. foro passante
Double short 90° passing through joint for tubes Ø18 mm.

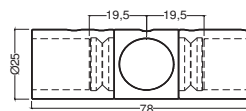

TO25185G2M NKS
TO25186G2M CR

2
2

8032611958564
8032611958571



3 10 A

Morsetto barra doppia 2 fori ciechi
Double bar clip 2 blind holes

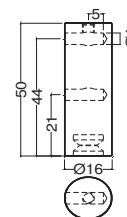

MB5052C	NKS	4	8032611954221
MB5062C	CR	4	8032611954238

3 10 B

Morsetto barra doppia 2 fori ciechi + 2 fori a 90°
Double bar clip 2 blind holes + 2 90° blind holes

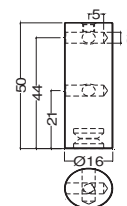

MB5054C	NKS	4	8032611954245
MB5064C	CR	4	8032611954252

3 10 C

Morsetto barra doppia 2 fori passanti
Double bar clip 2 passing through holes

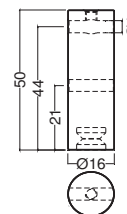

MB5052P	NKS	4	8032611954269
MB5062P	CR	4	8032611954276

3 10 D

Morsetto barra doppia 2 fori ciechi + 2 passanti a 90°
Double bar clip 2 blind holes + 2 90° passing through holes

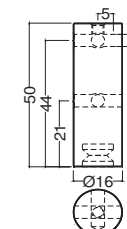

MB5052CP	NKS	4	8032611954283
MB5062CP	CR	4	8032611954290

3 10 E

Morsetto barra doppia 2 fori ciechi con rosetta
Double bar clip 2 blind holes with washer

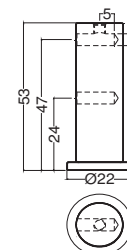

MB5052CR	NKS	4	8032611955129
MB5062CR	CR	4	8032611955136

**3 MORSETTI
CLIPS**

Pz./ CONF.
Pcs. / BOX

PREZZO CAD.
PRICE EACH

CODICE EAN 13
EAN 13 CODE

3 10 F

Morsetto barra doppia 2 fori ciechi + 2 fori a 90° con rosetta
Double bar clip 2 blind holes + 2 90° blind holes with washer

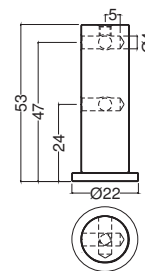

MB5054CR	NKS	4	8032611955143
MB5064CR	CR	4	8032611955150

3 10 G

Morsetto barra doppia 2 fori passanti con rosetta
Double bar clip 2 passing through holes with washer

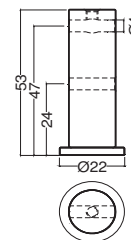

MB5052PR	NKS	4	8032611955167
MB5062PR	CR	4	8032611955174

3 10 H

Morsetto barra doppia 2 fori ciechi + 2 passanti a 90° con rosetta
Double bar clip 2 blind holes + 2 90° passing through holes with washer

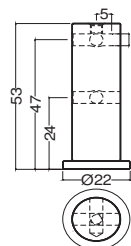

MB5052CPR	NKS	4	8032611955181
MB5062CPR	CR	4	8032611955198

Barra Ø4mm. AISI304 satinata rettificata

** realizzabile il taglio a misura



Bar Ø4mm. AISI304 satin grinded

** customised cut on request

BA040109	mt. 0,10	10	8032611954078
BA040209	mt. 0,20	10	8032611954085
BA040309	mt. 0,30	10	8032611954092
BA040409	mt. 0,40	10	8032611954108
BA040509	mt. 0,50	10	8032611954115
BA040609	mt. 0,60	10	8032611954122
BA040709	mt. 0,70	10	8032611954139
BA040809	mt. 0,80	10	8032611954146
BA040909	mt. 0,90	10	8032611954153
BA041009	mt. 1,00	10	8032611954160
BA041109	mt. 1,10	10	8032611954177
BA041209	mt. 1,20	10	8032611954184
BA041309	mt. 1,30	10	8032611950544
BA041409	mt. 1,40	10	8032611950568
BA041509	mt. 1,50	10	8032611950575
BA041609	mt. 1,60	10	8032611950599
BA041709	mt. 1,70	10	8032611950605
BA041809	mt. 1,80	10	8032611950629
BA041909	mt. 1,90	10	8032611950636
BA042009	mt. 2,00	10	8032611950650
BA042109	mt. 2,10	10	8032611950667
BA042209	mt. 2,20	10	8032611950681
BA042309	mt. 2,30	10	8032611950698
BA042409	mt. 2,40	10	8032611950711
BA042509	mt. 2,50	10	8032611954191
BA042609	mt. 2,60	10	8032611950926
BA042709	mt. 2,70	10	8032611950728
BA042809	mt. 2,80	10	8032611950940
BA042909	mt. 2,90	10	8032611950957
BA043009	mt. 3,00	10	8032611950742

NOTE

- Da utilizzare solo con i sistemi per barra
- Per una corretto fissaggio dei componenti, realizzare una tacca sulla barra dove richiesto
- Per dimensioni lunghe in posizione orizzontale utilizzare un elemento rompitratte ogni 40 cm
- Quando si utilizzano i supporti per tende inserire un elemento rompitratte ogni 50 cm per lunghe dimensioni

NOTES

- To be used only with bar systems
- For the right fixing of the components, do a notch on the bar where requested
- Use a distance breaker element each 40 cm for horizontal long dimensions
- When use as curtains' support, insert a distance breaker element each 50 cm for long dimensions

3 12 A

Morsetto barra singola 1 foro cieco
Clip for single bar 1 blind hole

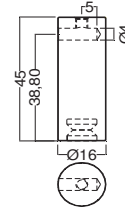

MB455C	NKS	4	8032611954306
MB456C	CR	4	8032611954313

3 12 B

Morsetto barra singola 1 foro cieco + 1 a 90°
Clip for single bar 1 blind hole + 1 90°

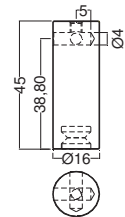

MB4552C	NKS	4	8032611954320
MB4562C	CR	4	8032611954337

3 12 C

Morsetto barra singola 1 foro passante
Clip for single bar 1 passing through hole

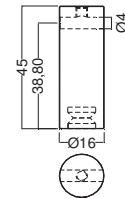

MB455P	NKS	4	8032611954344
MB456P	CR	4	8032611954351

3 12 D

Morsetto barra singola 1 foro cieco con rosetta
Clip for single bar 1 blind hole with washer

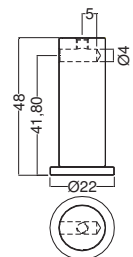

MB455CR	NKS	4	8032611955204
MB456CR	CR	4	8032611955211

3 12 E

Morsetto barra singola 1 foro cieco + 1 a 90° con rosetta
Clip for single bar 1 blind hole + 1 90° with washer

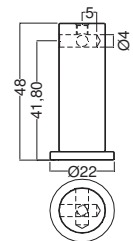

MB4552CR	NKS	4	8032611955228
MB4562CR	CR	4	8032611955235

3 12 F

Morsetto barra singola 1 foro passante con rosetta
Clip for single bar 1 passing through hole with washer

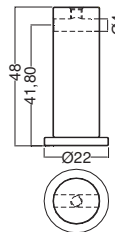

MB455PR	NKS	4
MB456PR	CR	4

8032611955242
8032611955259

3 12 G

Morsetto barra singola 1 foro cieco con rosetta - grano interno -
Clip for single bar 1 blind hole with washer - inner screw -

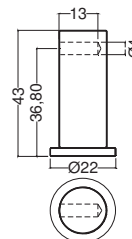

MB405CR	NKS	4
MB406CR	CR	4

8032611958663
8032611958670



3 12 H

Morsetto barra singola 1 foro passante con rosetta - grano interno -
Clip for single bar 1 passing through hole with washer - inner screw -

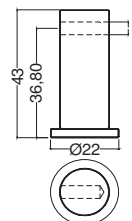

MB405PR	NKS	4
MB406PR	CR	4

8032611958700
8032611958717



3 13

"UTIHLIA" kit portatutto con rosetta
"UTIHLIA" hanging kit with washer

Viti e tasselli inclusi
Screws and fixing plugs included

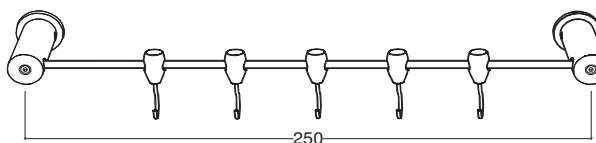

UT11	NKS	1
UT12	CR	1

8032611953927
8032611953934

3 14

Morsetto di testa Ø16 mm. per barra
Head mounting clip Ø16 mm. for bar

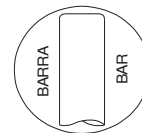
**MB16105KT NKS**

20

8032611955266

MB16106KT CR

20

8032611955273

3 15

Morsetto di testa doppio Ø16 mm. per barra
Double head mounting clip Ø16 mm. for bar

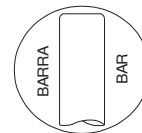
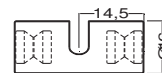
**MB16105K2T NKS**

10

8032611955280

MB16106K2T CR

10

8032611955297

3 16 A

Morsetto orientabile per pannelli mm. 7 per barra
Orientable clip for panels mm. 7 for bar

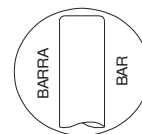
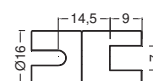
**MB16075IT NKS**

20

8032611955303

MB16076IT CR

20

8032611955310

3 16 B

Morsetto orientabile per pannelli mm. 11 per barra
Orientable clip for panels mm. 11 for bar

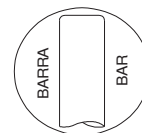
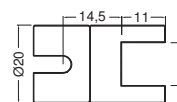
**MB20115IT NKS**

20

8032611955327

MB20116IT CR

20

8032611955334

3 16 C

Morsetto orientabile per pannelli mm. 3 per barra
Orientable clip for panels mm. 3 for bar

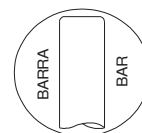
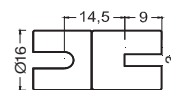
**MB16035IT NKS**

20

8032611957291

MB16036IT CR

20

8032611957307

3 17 A

Morsetto orientabile doppio per pannelli mm. 7 per barra
Double orientable clip for panels mm. 7 for bar

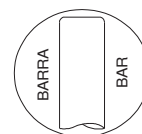
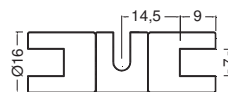
**MB16075I2T NKS**

10

8032611955365

MB16076I2T CR

10

8032611955372

3 17 B

Morsetto orientabile doppio per pannelli mm. 11 per barra
Double orientable clip for panels mm. 11 for bar

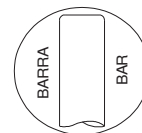
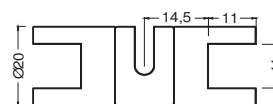
**MB20115I2T NKS**

10

8032611955389

MB20116I2T CR

10

8032611955396

3 17 C

Morsetto orientabile doppio per pannelli mm. 3 per barra
Double orientable clip for panels mm. 3 for bar

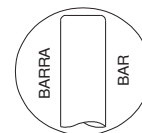
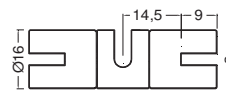
**MB16035I2T** NKS

10

8032611957314

MB16036I2T CR

10

8032611957321

3 18

Kit morsetto passante per barra
Passing through clip kit for bar

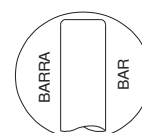
**MB125PKT** NKS

20

8032611955426

MB126PKT CR

20

8032611955433

3 18 B

Morsetto cilindrico per barra
Cylinder clip for bar

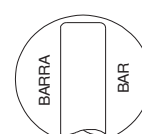
**MB14405** NKS

20

8032611950315

MB14406 CR

20

8032611958656

3 19 A

Morsetto fissabarra a scomparsa
Foldaway clip for bar

Richiede l'esecuzione di una tacca sulla barra
Needs a notch on the bar

**MF1004** NK

20

8032611955440

3 20 A

Morsetto per tubi arredo Ø18x1 mm. singolo per barra
Clip for furnishing tubes Ø18x1 mm. for bar

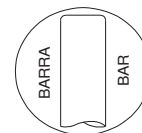
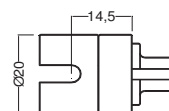
**MBT20185K** NKS

8

8032611955457

MBT20186K CR

8

8032611955464

3 20 B

Morsetto per tubi arredo Ø18x1 mm. doppio per barra
Double clip for furnishing tubes Ø18x1 mm. for bar

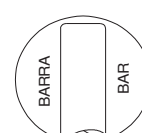
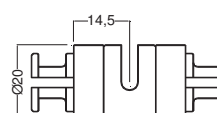
**MBT20185K2** NKS

4

8032611955471

MBT20186K2 CR

4

8032611955488

3 21 A

Morsetto collegamento barra-barra
Bar-bar clip joint

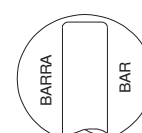
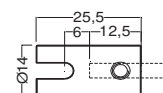
**MB14045K** NKS

10

8532611956126

MB14046K CR

10

8532611956133

3 21 B

Morsetto collegamento cavo-barra
Cable-bar clip joint

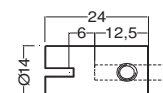
**MR14045K** NKS

10

8532611956140

MR14046K CR

10

8532611956157

3 22 A

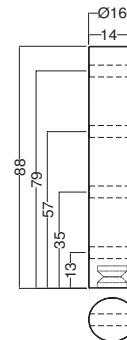
Supporto barra 4 fori ciechi
Support for bar 4 blind holes**MB168854C** NKS

4

8032611956515

MB168864C CR

4

8032611956522

3 22 B

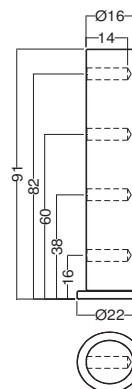
Supporto barra 4 fori ciechi con rosetta
Support for bar 4 blind holes with washer**MB168854CR** NKS

4

8032611956539

MB168864CR CR

4

8032611956546

3 23 A

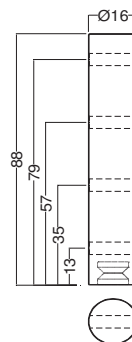
Supporto barra 4 fori passanti
Support for bar 4 passing through holes**MB168854P** NKS

4

8032611956553

MB168864P CR

4

8032611956560

3 23 B

Supporto barra 4 fori passanti con rosetta
Support for bar 4 passing through holes with washer

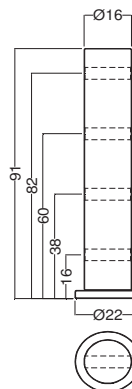

MB168854PR NKS

4

8032611956577

MB168864PR CR

4

8032611956584

3 24 A

Supporto lungo per barra 2 fori ciechi
Long support for bar 2 blind holes

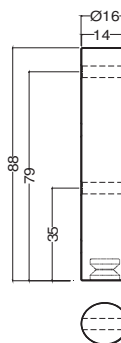

MB168852C NKS

4

8032611956591

MB168862C CR

4

8032611956607

3 24 B

Supporto lungo per barra 2 fori ciechi con rosetta
Long support for bar 2 blind holes with washer

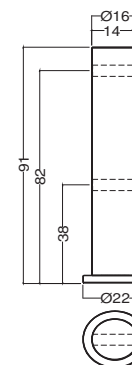

MB168852CR NKS

4

8032611956614

MB168862CR CR

4

8032611956621

3 25 A

Supporto lungo per barra 2 fori passanti
Long support for bar 2 passing through holes

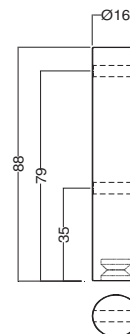

MB168852P	NKS	4
MB168862P	CR	4

8032611956638
8032611956645

3 25 B

Supporto lungo per barra 2 fori passanti con rosetta
Long support for bar 2 passing through with washer

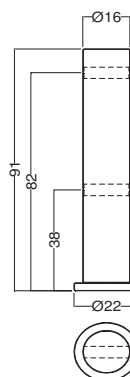

MB168852PR	NKS	4
MB168862PR	CR	4

8032611956652
8032611956669

3 26

Supporto orizzontale a parete per barra
Horizontal wall support for bar

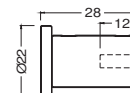

MB16285R	NKS	10
MB16286R	CR	10

8032611957338
8032611957345

3 28

Morsetto terminale per barra Ø12x15

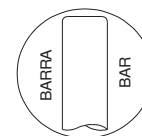

MF12405T	NKS	4
MF12406T	CR	4

8032611951961
8032611958588

4 01 A

Bottono Ø16 mm. - Supporto per pannelli
"Bottono" - Panel hanger Ø16 mm.

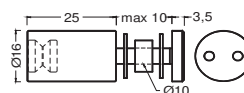

BT165	NKS	4	8032611951442
BT166	CR	4	8032611951459

4 01 B

Bottono Ø16 mm. - Supporto per pannelli con rosetta
"Bottono" - Panel hanger Ø16 mm. with washer

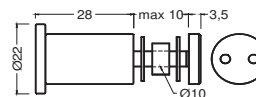

BT165R	NKS	4	8032611952432
BT166R	CR	4	8032611952449

4 01 C

Bottono Ø20 mm. - Supporto per pannelli
"Bottono" - Panel hanger Ø20 mm.

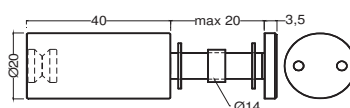

BT205	NKS	4	8032611953514
BT206	CR	4	8032611953521

4 01 D

Bottono Ø20 mm. - Supporto per pannelli con rosetta
"Bottono" - Panel hanger Ø20 mm. with washer

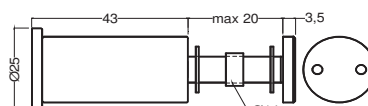

BT205R	NKS	4	8032611953538
BT206R	CR	4	8032611953545

4 02 A

Ferma pannelli frontale corto Ø16 per 7 mm.
7 mm. Ø16 short front wall panel hanger

Utilizzabile anche con il sistema magnetico piccolo
Can be used with little magnetic system

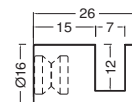

FP16075FCT	NKS	10	8032611954368
FP16076FCT	CR	10	8032611954375

4 02 B

Ferma pannelli frontale corto Ø16 per 7 mm. con rosetta
7 mm. Ø16 short front wall panel hanger with washer

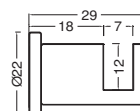

FP16075FCRT	NKS	10	8032611954382
FP16076FCRT	CR	10	8032611954399

4 02 C

Ferma pannelli frontale Ø16 per 7 mm. con rosetta
7 mm. Ø16 front wall panel hanger with washer

Disponibile anche nella versione "easy lock" (rif. 413B)
Also available in the "easy lock" version (rif. 413B)

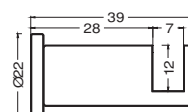

FP16075FT	NKS	10	8032611954405
FP16076FT	CR	10	8032611954412

4 02 D

Ferma pannelli frontale Ø20 per 11 mm.
11 mm. Ø20 front wall mm. panel hanger

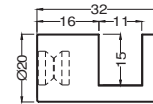

FP20325FCT NKS

10

8032611954528

FP20326FCT CR

10

8032611954535

4 02 E

Ferma pannelli frontale Ø20 per 11mm. con rosetta
11 mm. Ø20 front wall mm. panel hanger with washer

Disponibile anche nella versione "easy lock" (rif. 413B)

Also available in the "easy lock" version (rif. 413B)

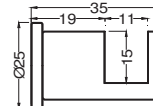

FP20325FCRT NKS

10

8032611954542

FP20326FCRT CR

10

8032611954559

4 02 F

Ferma pannelli frontale corto Ø16 per 3 mm.
3 mm. Ø16 front wall panel hanger

Utilizzabile anche con il sistema magnetico piccolo
Can be used with little magnetic system

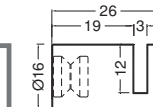

FP16035FCT NKS

10

8032611957352

FP16036FCT CR

10

8032611957369

4 02 G

Ferma pannelli frontale Ø16 per 3 mm. con rosetta
3 mm. Ø16 front wall panel hanger with washer

Disponibile anche nella versione "easy lock" (rif. 413B)

Also available in the "easy lock" version (rif. 413B)

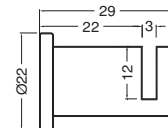

FP16035FCRT NKS

10

8032611957376

FP16036FCRT CR

10

8032611957383

4 03 A

Ferma pannelli a bandiera Ø16 per 7 mm. con rosetta
7 mm. Ø16 orthogonal panel hanger with washer

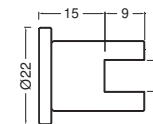

FP16075BT NKS

10

8032611954429

FP16076BT CR

10

8032611954436

4 03 B

Ferma pannelli a bandiera Ø20 per 11 mm. con rosetta
11 mm. Ø20 orthogonal panel hanger with washer

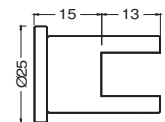

FP20115BT NKS

10

8032611954443

FP20116BT CR

10

8032611954450

4 03 C

Ferma pannelli da tavolo Ø20 per 11 mm.
11 mm. Ø20 table panel hanger

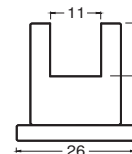

FP20115BVT NKS

10

8032611952951

FP20116BVT CR

10

8032611952968

4 03 D

Ferma pannelli a bandiera Ø16 per 7 mm.
7 mm. Ø16 orthogonal panel hanger

Utilizzabile anche con il sistema magnetico piccolo
Can be used with little magnetic system

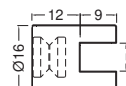

FP16075B	NKS	10
FP16076B	CR	10

8032611955532

8032611955549

4 03 E

Ferma pannelli a bandiera Ø16 per 3 mm.
3 mm. Ø16 orthogonal panel hanger

Utilizzabile anche con il sistema magnetico piccolo
Can be used with little magnetic system

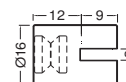

FP16035B	NKS	10
FP16036B	CR	10

8032611957390

8032611957406

4 03 F

Ferma pannelli a bandiera Ø16 per 3 mm. con rosetta
3 mm. Ø16 orthogonal panel hanger with washer

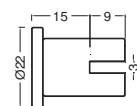

FP16035BT	NKS	10
FP16036BT	CR	10

8032611957413

8032611957420

4 03 G

Ferma pannelli a bandiera Ø20 per 7 mm. con rosetta
7 mm. Ø20 orthogonal panel hanger with washer

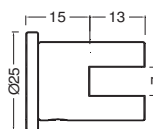

FP20075BT	NKS	10
FP20076BT	CR	10

8032611957437

8032611957444

4 03 H

Ferma pannelli a bandiera Ø20 per 3 mm. con rosetta
3 mm. Ø20 orthogonal panel hanger with washer

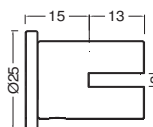

FP20035BT	NKS	10
FP20036BT	CR	10

8032611957451

8032611957568

4 03 I

Ferma pannelli a bandiera Ø25 per 14 mm. con rosetta
14 mm. Ø25 orthogonal panel hanger with washer

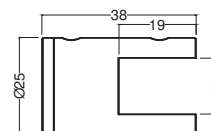

FP25305BT	NKS	4
FP25306BT	CR	4

8032611952104

8032611952111

4 04

Kit per pannelli sospesi
Cable panel hanger kit

Cavo non incluso
Cable not included

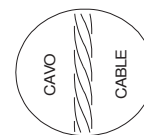
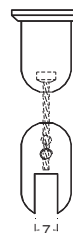

KPS165	NKS	10	8032611952975
KPS166	CR	10	8032611952982

4 05

Tendicavo a soffitto con rosetta e morsetto
Fixed top cable tensioner with washer and foldaway clip

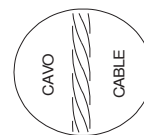
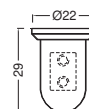

FC16125URM	NKS	10	8032611952456
FC16126URM	CR	10	8032611952463

4 06

Morsetto per pannelli sospesi mm. 7
Cable panel hanger clip mm. 7

Cavo non incluso
Cable not included

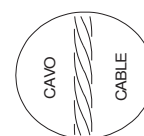
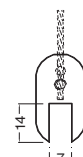

MR16305K	NKS	10	8532611956102
MR16306K	CR	10	8532611956119

4 06 B

Morsetto per pannelli sospesi mm. 3
Cable panel hanger clip mm. 3

Cavo non incluso
Cable not included

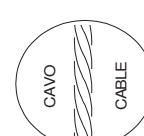

MR163035K	NKS	10	8032611957475
MR163036K	CR	10	8032611957482

4 06 C

Morsetto per pannelli sospesi mm. 14
Cable panel hanger clip mm. 14



Cavo non incluso
Cable not included

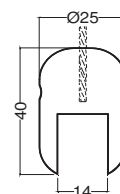

MR25405K	NKS	2	8032611958601
MR25406K	CR	2	8032611958618

4 07

Barra reggi pannelli a bandiera
Orthogonal panel hanger rod

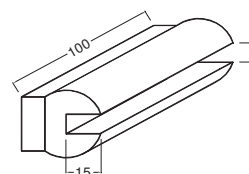

FPB1285	NKS	1	8032611951404
FPB1286	CR	1	8032611951411

4 08

Barra reggi pannelli frontale
Front wall panel hanger rod

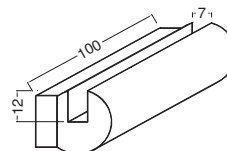

FPF1255	NKS	1	8032611951381
FPF1256	CR	1	8032611951398

4 09

Ferma pannelli a vite per cavo
Screw panel hanger for cable

Spessore massimo pannello mm. 6
Maximum panel thickness mm. 6

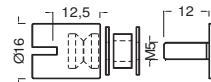

FPV16125	NKS	4	8032611954481
FPV16126	CR	4	8032611954498

4 10

Ferma pannelli a vite per barra
Screw panel hanger for bar

Spessore massimo pannello mm. 6
Maximum panel thickness mm. 6

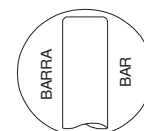
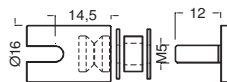

FBV16125	NKS	4	8032611955556
FBV16126	CR	4	8032611955563

4 11

Morsetto per pannelli sospesi mm. 7 per barra
Panel hanger clip mm. 7 for bar

Barra Ø 4 mm. non inclusa
Bar Ø 4 mm. not included

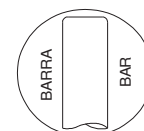

MB16305	NKS	10	8032611955570
MB16306	CR	10	8032611955587

4 11A

Morsetto per pannelli sospesi mm. 3 per barra
Panel hanger clip mm. 3 for bar

Barra Ø 4 mm. non inclusa
Bar Ø 4 mm. not included

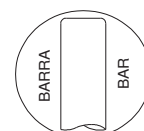
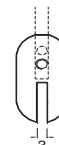

MB163035	NKS	10	8032611957499
MB163036	CR	10	8032611957506

4 12

Morsetto a parete per pannelli mm. 11
Wall clip for panels mm. 11

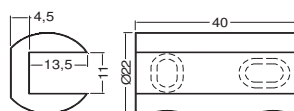

MR2240115K	NKS	4	8032611955846
MR2240116K	CR	4	8032611955853

4 13 A

Ferma pannelli frontale Ø20 per 3 mm. con rosetta
3 mm. Ø20 front wall panel hanger with washer

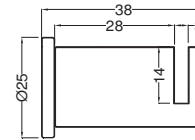

FP20035FLR	NKS	4	8032611957055
FP20036FLR	CR	4	8032611957062

4 13 B

Ferma pannelli frontale Ø20 per 7 mm. con rosetta
7 mm. Ø20 front wall panel hanger with washer

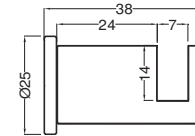

FP20075FLR	NKS	4	8032611957079
FP20076FLR	CR	4	8032611957086

4 13 C

Ferma pannelli frontale Ø20 per 11 mm. con rosetta
11 mm. Ø20 front wall panel hanger with washer

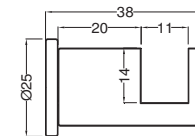

FP20115FLR	NKS	4	8032611957093
FP20116FLR	CR	4	8032611957109

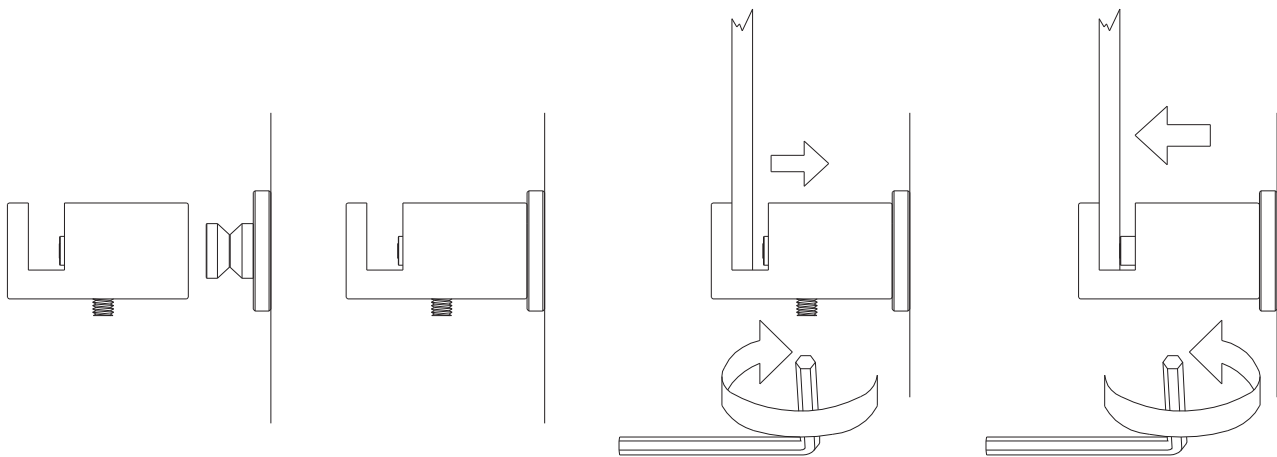

IL SISTEMA "EASY LOCK" PERMETTE UNA FACILE CHIUSURA DEGLI SPESSORI E IL POSIZIONAMENTO DELLA TARGA ANCHE DOPO AVER FISSATO IL SUPPORTO A PARETE

THE "EASY LOCK" SYSTEM ALLOWS EASY CLOSING AND POSITIONING OF THE PLAQUE EVEN AFTER THE INSTALLATION OF THE SUPPORT TO THE WALL

5 01

"INNOCENTE" penna da tavolo *
* personalizzazione su richiesta

"INNOCENTE" table pen **
** personalization on request

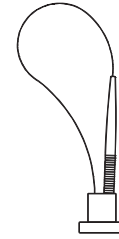

OPI001

1

8032611953026

5 02

"SPIROS" porta ombrelli
"SPIROS" umbrella-stand

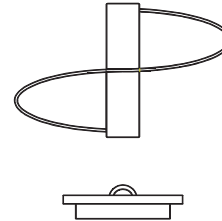

SPS9005 NKS
SPS9006 CR

1
1

8032611952746
8032611952753

5 03 A

Porta oggetti tondo da parete con morsetto
Wall tray with clip

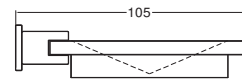

AR901695AKP CLIP NKS
AR901696AKP CLIP CR

1
1

8032611953040
8032611953057

5 03 B

Porta oggetti tondo da tavolo
Table tray

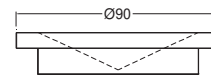

AR901690AK

1

8032611953064

5 04

Morsetto rompitratta
Distance breaker clip

Da usare con tendicavo 106C
(1 ogni 100 cm. ca. di cavo teso)

To be used with cable tensioner 106C
(1 about 100 cm. of tensioned cable)

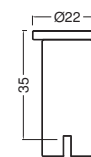

MR16375KT NKS
MR16376KT NKS

5
5

8032611951978
8032611951992

5 05 B

Coppia magneti
Magnet couple

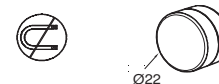

PM22145 NKS
PM22146 CR

5
5

8032611953194
8032611953200

5 05 C

Pinza magnetica schermata
Screened magnetic clip

Lunghezza cavo mm. 90
Cable length mm. 90



PZS22145
PZS22146

NKS
CR

5
5

8032611953347
8032611953354

5 05 D

Pinza magnetica schermata cavo lungo
Screened magnetic clip long cable

Lunghezza cavo mm. 180
Cable length mm. 180



PZS22145L
PZS22146L

NKS
CR

5
5

8032611953361
8032611953378

5 06

Morsetto appendi abiti
Cloack stand clip



AR18555K
AR18556K

NKS
CR

2
2

8032611952654
8032611952661

5 07 A

Reggimensola mm. 150 con supporto eccentrico
Bracket mm. 150 with eccentric support

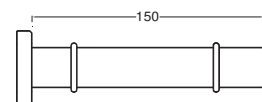
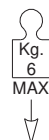

RM18155K
RM18156K

NKS
CR

2
2

8032611951602
8032611951619

5 07 B

Reggimensola mm. 180 con supporto eccentrico
Bracket mm. 180 with eccentric support

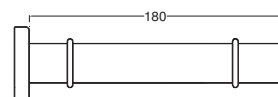

RM18185K
RM18186K

NKS
CR

2
2

8032611951626
8032611951633

5 07 C

Reggimensola mm. 200 con supporto eccentrico
Bracket mm. 200 with eccentric support

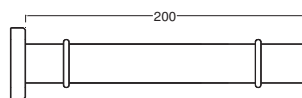

RM18205K
RM18206K

NKS
CR

2
2

8032611951640
8032611951657

5 07 D

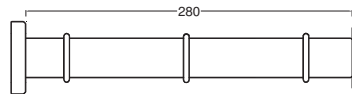
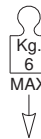
Reggimensola mm. 280 con supporto eccentrico
Bracket mm. 280 with eccentric supportCONSIGLIATO IL FISSAGGIO CHIMICO - non fornito
CHEMICAL FIXING SUGGESTED - not supplied

RM18285K NKS

2

RM18286K CR

2

8032611953491

8032611953507

5 07 E

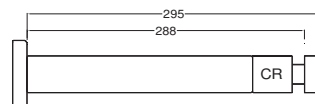
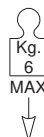
Supporto a parete per piastra per appenderia con supporto eccentrico
Wall bracket for hanging plate with eccentric support

SBP185 NKS

2

SBP186 CR

2

8032611956188

8032611956195

5 08

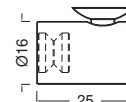
Reggi piano con ventosa
Bracket with sucker

MV16255KT NKS

20

MV16256KT CR

20

8032611952883

8032611952906

5 10

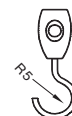
Scorrevole con gancio
Sliding hook

SG10165 NKS

10

SG10166 CR

10

8032611953255

8032611953262

5 11

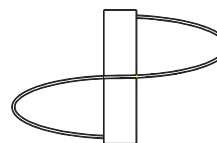
Embrasse "SPIROS"
"SPIROS" embrasseCavo fisso
Fixed cable

SPE9005 NKS

1

SPE9006 CR

1

8032611953217

8032611953224

5 14

"Vitra" porta spezie
"Vitra" spice holder

Vetro pyrex - Guarnizioni uso alimentare
Pyrex glass - Food safe gaskets

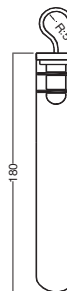

PS165	NKS	1
PS166	CR	1

8032611953422
8032611953439

5 15

Ferma porta
Door stopper

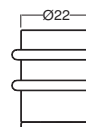

FP22115	NKS	4
FP22116	CR	4

8032611953590
8032611953606

5 16 A

Supporto cieco per tende
Blind clip for curtains

Vite legno M3x25 inclusa
Wood screw M3x25 included



BB145C	NKS	10
BB146C	CR	10

8032611954740
8032611954757

5 16 B

Supporto passante per tende
Passing through clip for curtains

Vite legno M3x25 inclusa
Wood screw M3x25 included

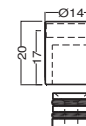

BB145P	NKS	10
BB146P	CR	10

8032611954764
8032611954771

5 17

Kit porta rotolo
Toilette roll holder kit

Rosette e tasselli per fissaggio inclusi
Washers and anchors included

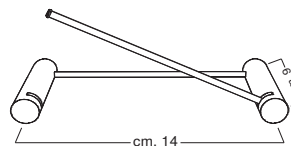

IDC05	NKS	NKS	1
IDC06	CR	CR	1

8032611956430
8032611956447

5 18

Kit porta sapone
Soap holder kit

Rosette e tasselli per fissaggio inclusi
Washers and anchors included

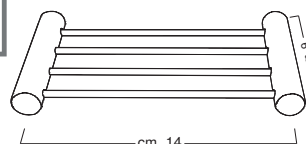

IDS05	NKS	NKS	1
IDS06	CR	CR	1

8032611956454
8032611956461

n.b. Supporti disponibili anche singolarmente (sia nella versione con fori ciechi RIF. 322 che con fori passanti RIF. 323) per soluzioni personalizzate.

n.b. Blind hole support RIF. 322 or passing through hole support RIF. 323 available for custom solutions.

5 18 A

Ripiano cm. 30
Shelf cm. 30

Rosette e tasselli per fissaggio inclusi
Washers and anchors included

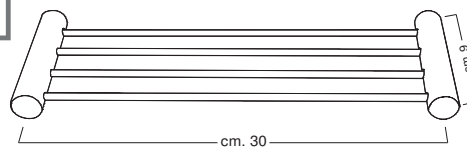

IDR35	NKS	NKS	1	8032611956676
IDR36	CR	CR	1	8032611956683

n.b. Supporti disponibili anche singolarmente (sia nella versione con fori ciechi RIF. 322 che con fori passanti RIF. 323) per soluzioni personalizzate.

n.b. Blind hole support RIF. 322 or passing through hole support RIF. 323 available for custom solutions.

5 18 B

Ripiano cm. 60
Shelf cm. 60

Rosette e tasselli per fissaggio inclusi
Washers and anchors included

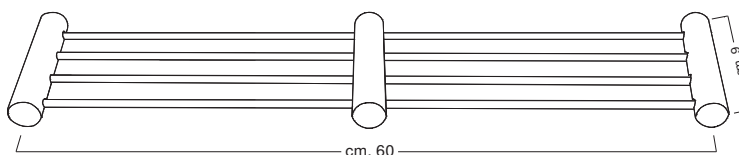

IDR65	NKS	NKS	1	8032611956690
IDR66	CR	CR	1	8032611956706

n.b. Supporti disponibili anche singolarmente (sia nella versione con fori ciechi RIF. 322 che con fori passanti RIF. 323) per soluzioni personalizzate.

n.b. Blind hole support RIF. 322 or passing through hole support RIF. 323 available for custom solutions.

5 19

Kit porta spazzolino
Toothbrush holder kit

Rosette e tasselli per fissaggio inclusi
Washers and anchors included



IDD05	NKS	NKS	2	8032611956478
IDD06	CR	CR	2	8032611956485

5 20

Kit porta asciugamano
Towel rail kit

Rosette e tasselli per fissaggio leggero inclusi
Washers and anchors included

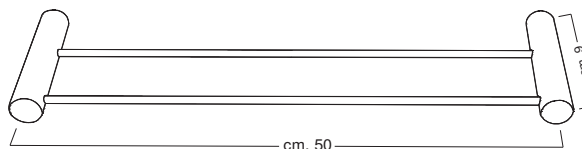

IDA05	NKS	NKS	1	8032611956492
IDA06	CR	CR	1	8032611956508

n.b. Supporti disponibili anche singolarmente (sia nella versione con fori ciechi RIF. 324 che con fori passanti RIF. 325) per soluzioni personalizzate.

n.b. Blind hole support RIF. 324 or passing through hole support RIF. 325 available for custom solutions.

5 21

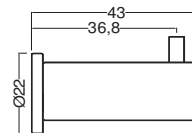
Supporto appendiabiti da parete
Wall hanger support

AR16405	NKS	NKS	2	8032611957116
AR16406	CR	CR	2	8032611957123

5 21 B

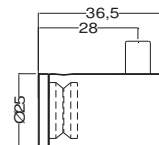
Supporto appendiabiti GRANDE da parete
BIG Wall hanger support

AR25365	NKS	NKS	2	8032611958236
AR25366	CR	CR	2	8032611958243

5 22

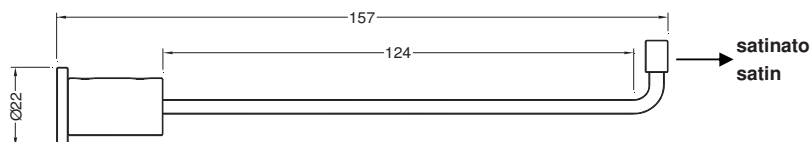
Porta cinture a parete
Wall belt hanger

PC165RT	NKS	NKS	2	8032611957512
PC166RT	CR	CR	2	8032611957529

6 01

KIT SOLO

composto da morsetto 301 - morsetto 602 - morsetto 603 - cavo 202 mt. 2
 composed of clip 301 - clip 602 - clip 603 - cable 202 mt. 2

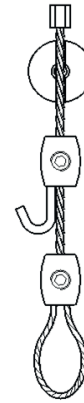

KS205T	NKS	1	8032611951572
KS206T	CR	1	8032611951596

6 02

Morsetto oliva con gancio
 Olive clip with hook

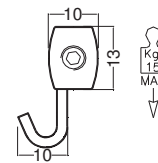

MF10205BQAT	NKS	10	8032611951473
MF10206BQAT	CR	10	8032611951497

6 02 B

Morsetto oliva con gancio con autobloccaggio
 Self lock olive clip with hook

Da usare con cavo 602C
 To be used with cable 602C

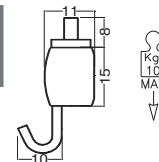

MF12135BQM	NKS	10	8032611951817
MF12136BQM	CR	10	8032611951824

6 02 C

Cavo Ømm. 1,30 AISI316 49 fili con cilindro Ø6x3.50 saldato per sistema MOMA
 Cable Ømm. 1,30 AISI316 49 wires with Ø6x3.50 welded cylinder for MOMA system

Da usare con morsetto 602B
 To be used with clip 602B

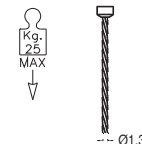

CA13005XMB	mt. 0,50	10	8032611951862
CA13010XMB	mt. 1,00	10	8032611951879
CA13015XMB	mt. 1,50	10	8032611951893
CA13020XMB	mt. 2,00	10	8032611951909
CA13025XMB	mt. 2,50	10	8032611951916
CA13030XMB	mt. 3,00	10	8032611951923

6 03

Morsetto oliva per cappio
 Olive clip for cable noose

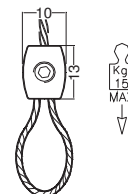

MF10205BKT	NKS	10	8032611951534
MF10206BKT	CR	10	8032611951558

6 04

Morsetto di fissaggio con rosetta
Wall mounting clip with washer

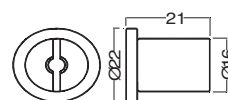
**MR16105KRT NKS**

20

8032611953071

MR16106KRT CR

20

8032611953088

6 05

Binario alluminio mt. 2,50
Alluminium rail mt. 2,50

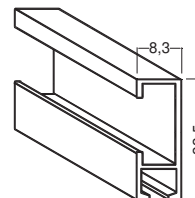
**PA258 ARGENTO****SILVER**

1

8032611951664

PA259 BIANCO**WHITE**

1

8032611951886

6 06

Supporto a parete a scatto per binario in ottone
Brass click wall mounting for rail

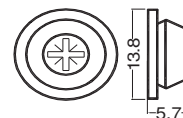
**WS103****NK**

50

8032611956409

6 07

Terminale per binario
Screw end for rail

**WS300****NK**

20

8032611951688

6 08

Supporto/giunzione per binari in ottone
Brass wall mounting and joint for rails

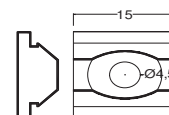
**WS403****NK**

10

8032611953910

6 09

Tappo terminale per binario
End cap for rail

**WS505****NKS**

10

8032611954504

WS506**CR**

10

8032611954511

WS509 BIANCO**WHITE**

10

8032611958427

6 10 A

Supporto a soffitto per binario
Top support for single rail

rif.606 incluso
rif.606 included



WS615K **NKS**

5

8032611956003

WS616K **CR**

5

8032611956010

6 10 B

Supporto a soffitto per binario con rosetta
Top support for single rail with washer

rif.606 incluso
rif.606 included



WS615KR **NKS**

5

8032611956027

WS616KR **CR**

5

8032611956034

6 11 A

Supporto a soffitto per binario doppio
Top support for double rail

rif.606 incluso
rif.606 included



WS625K **NKS**

5

8032611956041

WS626K **CR**

5

8032611956058

6 11 B

Supporto a soffitto per binario doppio con rosetta
Top support for double rail with washer

rif.606 incluso
rif.606 included



WS625KR **NKS**

5

8032611956065

WS626KR **CR**

5

8032611956072

6 12

Supporto per barra scorrevole
Sliding support for bar

NEW

Richiede l'esecuzione di una tacca sulla barra
Needs a notch on the bar

Da usare con profilo 605
To be used with rail 605

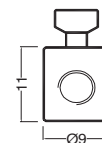

MB10045B **NKS**

4

8032611958120

MB10046B **CR**

4

8032611958137

7 00

Portachiavi acciaio inox satinato *** personalizzabile su preventivo
Satin Stainless Steel key holder *** customisable in request

TAHBU1

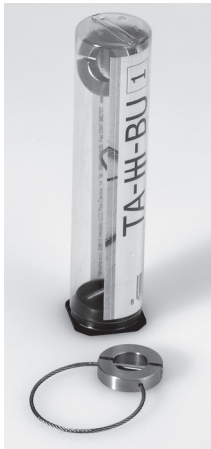

TAHBU2



TAHBU3



TAHBU4

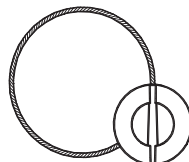
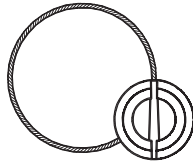
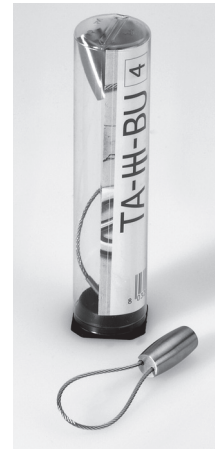

1

PROMO
PRICE

7 05 A

Porta foto con due supporti (NKS o CR) e due fogli di plexiglass trasparente
Picture frame with two supports (NKS or CR) and 2 plexiglass sheets



cm. 10x15
cm. 15x18

1

1

PROMO
PRICE

7 07

Portaborse da tavolo *
* personalizzazione su richiesta

Table bag hanger **
** personalization on request

PROMO
PRICE

PB45XS ACCIAIO INOX SATINATO SATIN STAINLESS STEEL
PB45XL ACCIAIO INOX LUCIDO POLISHED STAINLESS STEEL

1

1

8032611955617
8032611956423

⚠ Prima di utilizzare qualunque tipo di fissaggio consultare i carichi ammessi dal produttore dei fissaggi.
Before using any type of fastenings, please consult the manufacturer for their loads capacity.

Dal sito www.tahuma.it sono scaricabili i file in formato .pdf con i disegni e gli schemi tecnici.
Download the .pdf files with technical drawings and diagrams from our website www.tahuma.it

7 08

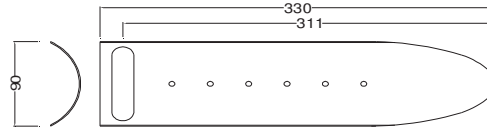
Vassoio portabottiglie " BOTO' "
" BOTO' " bottles tray

PB10A	grigio metallizzato	metallic gray	<i>prezzo su richiesta / price on request</i>
PB1A	verniciato colore	colour varnished	<i>prezzo su richiesta / price on request</i>
PBAX	cubicato	water transfer printed	<i>prezzo su richiesta / price on request</i>

7 09

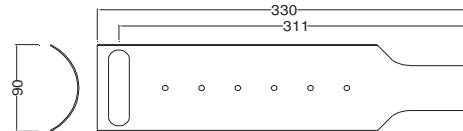
Vassoio portabottiglie " MODI' "
" MODI' " bottles iPB

PB10B	grigio metallizzato	metallic gray	<i>prezzo su richiesta / price on request</i>
PB1B	verniciato colore	colour varnished	<i>prezzo su richiesta / price on request</i>
PBBX	cubicato	water transfer printed	<i>prezzo su richiesta / price on request</i>

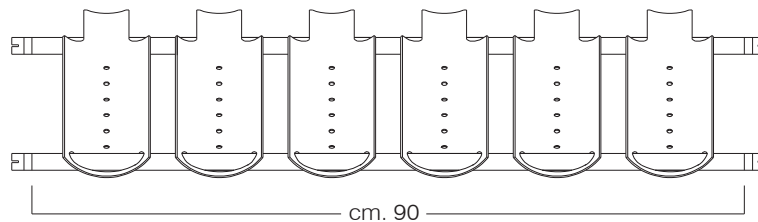
**QUESTO MODULO**

- nr. 6 Vassoi portabottiglie rif. 708 / 709
nr. 2 Tubi AISI304 cm. 90 cod. TB180909
nr. 4 Morsetti per tubo NKS rif. 308A

THIS MODULE

- nr. 6 Bottles trays ref. 708 / 709
nr. 2 AISI304 tubes cm. 90 cod. TB180909
nr. 4 Clips for cables NKS ref. 308A

PER LA STRUTTURA AGGIUNGERE:

- a) pz. 4 Cavi Ø2 mm. rif. 201 / barre Ø4mm. rif. 311
b) pz. 4 Tenditori rif. 107
c) pz. 4 Morsetti collegamento rif. 321B/321A
d) pz. 2 Barre Ø4mm. Lunghezza cm. 30 - cod. BA040309

FOR THE STRUCTURE ADD:

- a) pcs. 4 Cables Ø2 mm. rif. 201 / bars Ø4mm. rif. 311
b) pcs. 4 Tensioners rif. 107
c) pcs. 4 Joint clips rif. 321B/321A
d) pcs. 2 Bars Ø4mm. Length cm. 30 - cod. BA040309

!! OGNI ULTERIORI 2 MODULI AGGIUNGERE VOCI c) e d)**!! EACH 2 ADDITIONAL MODULES ADD ITEMS c) and d)**

7 15 A

Morsetto Ø14 per barra a U
Ø14 clip for U shaped bar

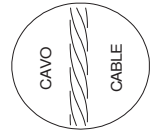
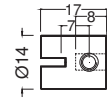

MR1417045K NKS
MR1417046K CR

4
4

8032611958434
8032611958724

7 15 B

Morsetto doppio Ø14 per barra a U
Ø14 double clip for U shaped bar

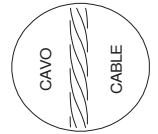
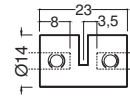

MR1423045K NKS
MR1423046K CR

2
2

8032611958441
8032611958731

7 15 C

Barra Ø4mm AISI304 sagomata a U
Ø4 U shaped AISI304 bar

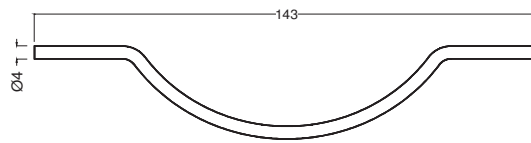

BA04156XU AISI304

2

8032611958458

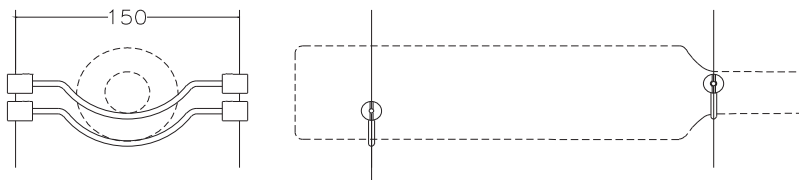
**QUESTO MODULO**

nr. 2 Barre sagomate rif. 715C
nr. 4 morsetti per barra a U rif. 715A

PER LA STRUTTURA AGGIUNGERE:

- a) pz. 4 Cavi Ø2 mm. rif. 201
b) pz. 4 Tenditori rif. 107

COMPOSIZIONI MULTIPLE POSSIBILI

AGGIUNGENDO MODULI SULLA STESSA COLONNA

BY ADDING MODULS ON THE SAME COLUMN

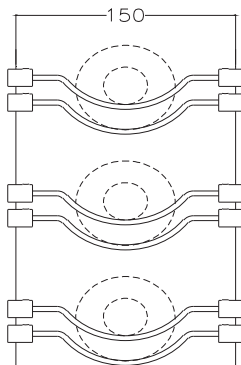
**THIS MODULE**

nr. 2 U shaped bars rif. 715C
nr. 4 clips for U shaped bar rif. 715A

FOR THE STRUCTURE ADD:

- a) pcs. 4 Cables Ø2 mm. rif. 201
b) pcs. 4 Tensioners rif. 107

MULTIPLE COMPOSITIONS POSSIBLE

AGGIUNGENDO MORSETTI DOPPI (rif. 715B) E BARRE SAGOMATE (rif. 715C)
SU ULTERIORI COLONNE

BY ADDING DOUBLE CLIPS (rif. 715B) AND U SHAPED BARS (rif. 715C)
ON ADDITIONAL COLUMNS

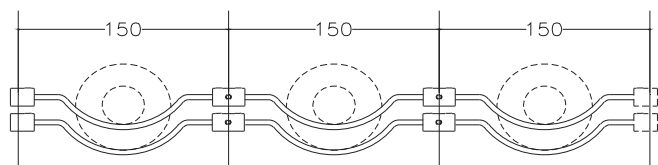

7 10

Contenitore Gustavo - Gustavo box

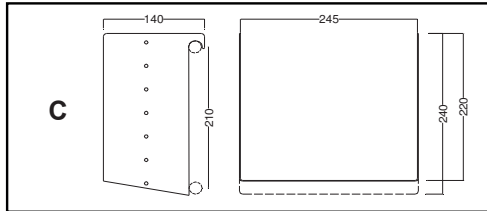
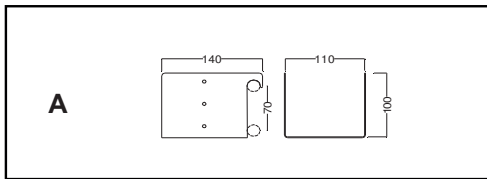
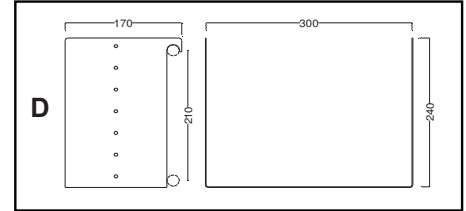
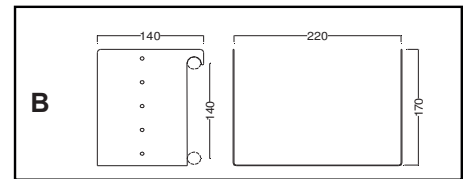
*prezzo su richiesta / price on request*

7 11

Ripiano Gustavo Shelf - Gustavo Shelf

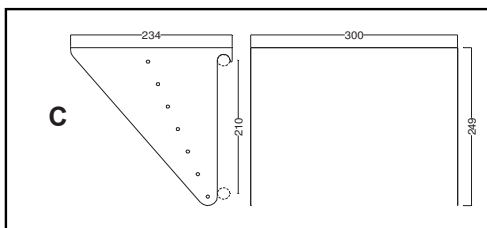
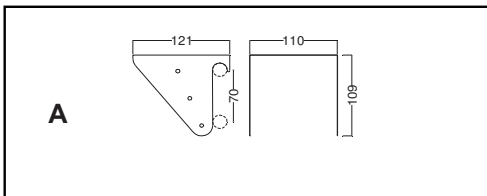
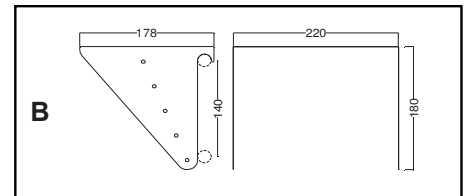
*prezzo su richiesta / price on request*

7 12

Contenitore Gustavo Wall - Gustavo Wall box

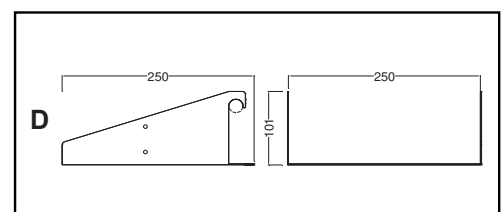
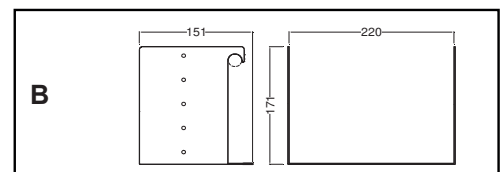
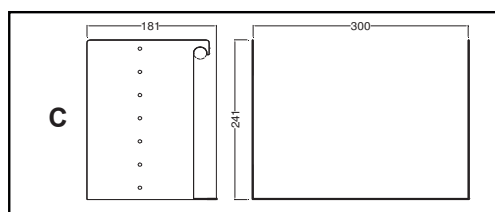
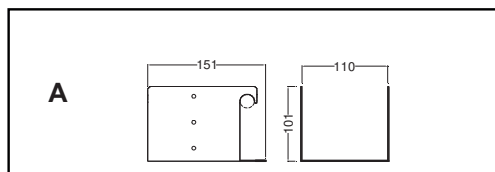
*prezzo su richiesta / price on request***DA UTILIZZARE CON SUPPORTI RIF. 309G, 309H, 309A OPPURE 309L - 1 supporto ogni 60 cm. circa****TO BE USED WITH SUPPORTS RIF. 309G, 309H, 309A or 309L - 1 support every 60 cm.**

7 13

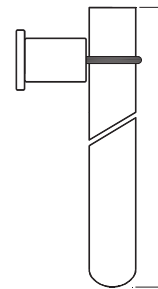
Vaso monofiore con supporto
Bud vase with supportViti e tasselli inclusi
Screws and fixing plugs included

SF1605

NKS

1

8032611957130

SF1606

CR

1

8032611957147

7 14 A

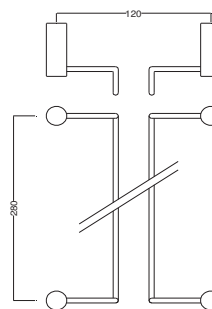
Modulo porta bicchieri
Glass rack

GH165B

NKS

1

8032611957536

GH166B

CR

1

8032611957543

7 14 B

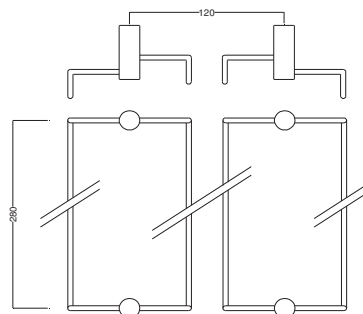
Modulo estensione per porta bicchieri
n.b. da abbinare al cod. 714AExtension for glass rack
n.b. to be combined with cod. 714A

GH165B2

NKS

1

8032611957550

GH166B2

CR

1

8032611957567

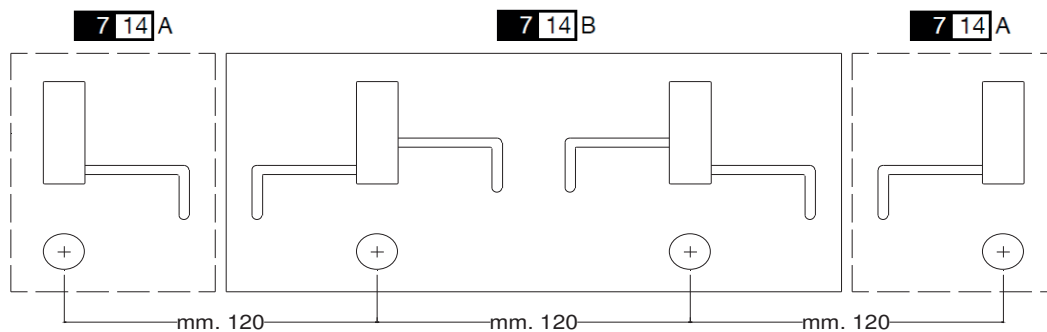
Esempio combinazione moduli
Exaple of modules combination1x714A + 714B = 3 file
1x714A + 714B = 3 raws1x 714A + 2x714B = 5 file
1x 714A + 2x714B = 5 raws

9 01

Inserto per fissaggio Ø10x8 mm. - M5
Fixing insert Ø10x8 mm. M5

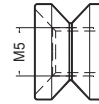

FG100805	NK	20	8032611952494
-----------------	-----------	----	---------------

9 02

Rosetta per fissacavi Ø22x4 mm.
Cable holder washer Ø22x4 mm.

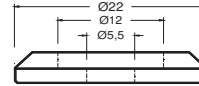

FC22045	NKS	20	8032611952678
FC22046	CR	20	8032611952685

9 03

Disco per reggipiano per cavi mm. 2
Cover disk for shelves

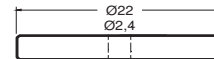

MF12205V1A	NKS	20	8032611952692
MF12206V1A	CR	20	8032611952708

9 04

Morsetto cilindro Ø12x15 mm.
Cylinder clip Ø12x15 mm.



MF12205AK	NKS	20	8032611952739
MF12206AK	CR	20	8032611952760

9 05

Rosetta di ancoraggio Ø22x3 mm.
Fixing washer Ø22x3 mm.

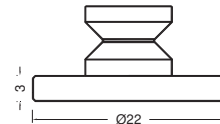

RA22115	NKS	10	8032611952562
RA22116	CR	10	8032611952579

9 05 A

Rosetta di ancoraggio Ø25x3 mm.
Fixing washer Ø25x3 mm.

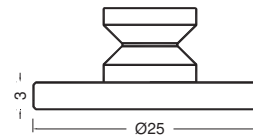

RA25115	NKS	10	8032611956201
RA25116	CR	10	8032611956218

9 06 A

Reggi pannelli a parete maschio Ø16x17 mm.
Male wall panel hanger Ø16x17 mm.

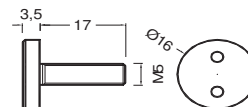

RPM16185	NKS	20	8032611952593
RPM16186	CR	20	8032611952609

9 06 B

Reggi pannelli a parete maschio Ø16x12 mm.
Male wall panel hanger Ø16x12 mm.

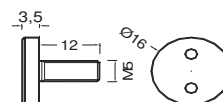

RPM16125 **NKS**

20

8032611952616

RPM16126 **CR**

20

8032611952623

9 06 C

Reggi pannelli a parete maschio Ø20x30 mm.
Male wall panel hanger Ø20x30 mm.

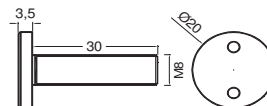

RPM20305 **NKS**

10

8032611951848

RPM20306 **CR**

10

8032611951855

9 07

Kit guarnizione per bottone Ø16 mm. (2 rondelle + 1 bussola)
"Bottone" Ø16 mm. gasket kit (2 washers + 1 bush)

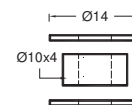
**KG**

20

8032611952630

9 07 A

Kit guarnizione per bottone Ø20 mm. (2 rondelle + 1 bussola)
"Bottone" Ø20 mm. gasket kit (2 washers + 1 bush)

**KGG**

10

8032611953842

9 08

Chiave a U
U spanner



KU per 401A e 401B (Ø16)

20

8032611952647

KUG per 402A e 402B (Ø20)

10

8032611953866

9 09 A

Distanziatore Ø16x25 mm. M5
Distance piece Ø16x25 mm. M5

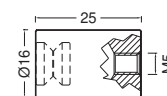

DPF16255K **NKS**

4

8032611952784

DPF16256K **CR**

4

8032611952791

9 09 B

Distanziatore Ø16x30 mm. M5
Distance piece Ø16x30 mm. M5

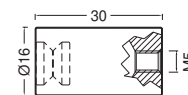

DPF16305K **NKS**

4

8032611952807

DPF16306K **CR**

4

8032611952814

9 09 C

Distanziatore Ø16x40 mm. M5
Distance piece Ø16x40 mm. M5

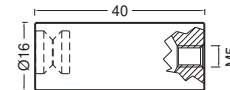

DPF16405K **NKS**

4

8032611952821

DPF16406K **CR**

4

8032611952838

9 09 D

Distanziatore Ø16x50 mm. M5
Distance piece Ø16x50 mm. M5

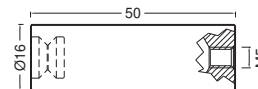

DPF16505K **NKS**

4

8032611952845

DPF16506K **CR**

4

8032611952852

9 10

Kit flangia
Flange kit

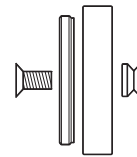

FG45115K **NKS**

2

8032611953972

FG45116K **CR**

2

8032611953989

9 11

Perno per fissaggio chimico M4
M4 nut for chemical fixing

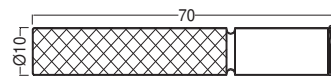

FK08604

10

8032611955952

9 13

Dado cilindrico Ø9x9,5 mm. M5 per tendicavo
Cylinder nut Ø9x9,5 mm. M5 for cable tensioner

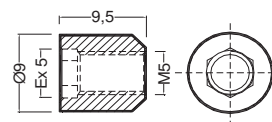

DT099553 **NK**

10

8032611953873

9 14

Dado cilindrico Ø9x20 mm. M5 per tendicavo
Cylinder nut Ø9x20 mm. M5 for cable tensioner

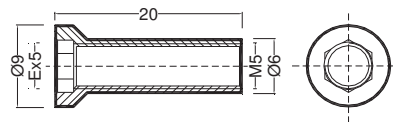

DT0920053 **NK**

10

8032611953880

9 15 A

Grano inox M4x4 punta cono 90°
Stainless steel M4x4 cone point screw



GR0404CX

50

8032611954696

9 15 B

Grano inox M4x4 punta piana
Stainless steel M4x4 flat point screw



GR0404PX

50

8032611954702

9 15 C

Grano inox M4x6 punta piana
Stainless steel M4x6 flat point screw

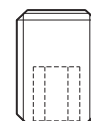

GR0406PX

50

8032611954719

9 15 D

Grano inox M4x5 con cappuccio
Stainless steel M4x5 dog point screw with cap

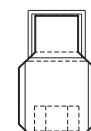

GR0405XN

50

8032611954689

9 16

Borchia Ø16 mm. M5
Threaded cap Ø16 mm. M5

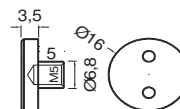

RPF165 NKS

10

8032611955686

RPF166 CR

10

8032611955693

9 16 A

Borchia Ø22 mm. M5
Threaded cap Ø22 mm. M5

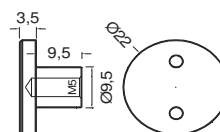

RPF225 NKS

10

8032611958267

RPF226 CR

10

8032611958274

9 16 B

Borchia Ø25 mm. M5
Threaded cap Ø25 mm. M5

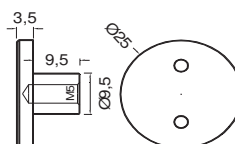

RPF255 NKS

10

8032611958281

RPF256 CR

10

8032611958298

9 17

Chiave esagonale EX2 zincata
Zinc-coated Ex2 wrench

CEX29

20

8032611955990

9 18

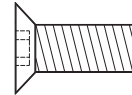
Vite a testa svasata piana con esagono incassato
Countersunk head socket screw

M4X8	INOX	50	8032611956324
M5X12	INOX	50	8032611950759
M5X16	INOX	50	8032611950773
M5X20	INOX	50	8032611956331
M5X25	INOX	50	8032611956348
M5X30	INOX	50	8032611956355
M5X35	INOX	50	8032611956362
M5X40	INOX	50	8032611956379
M5X45	INOX	50	8032611956386
M5X50	INOX	50	8032611956393

9 19

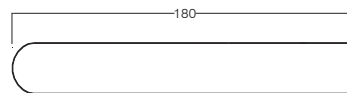
Provetta in Pyrex® Ø16x180 mm.
Ø16x180 mm. Pyrex® tube

PRO16K

1

8032611956416

9 20

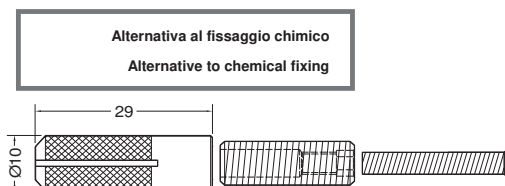
Kit per fissaggio pesante
Heavy fixing kit

TMK08

10

8032611958250



10 02

Lastra AISI304 satinato con pittogrammi toilette
Inox AISI304 satin plate toilet signs

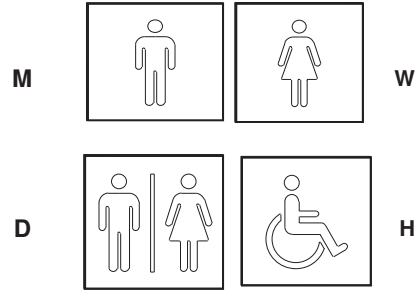

prezzo su richiesta / price on request

10 02 C

Targa adesiva AISI304 satinato
Adhesive AISI304 satin plate

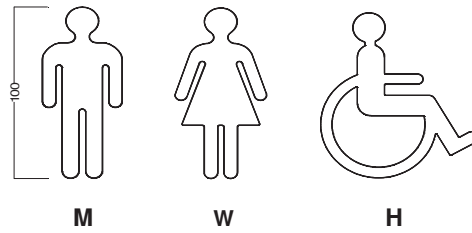

INX01/M

prezzo su richiesta / price on request

INX01/W

prezzo su richiesta / price on request

INX01/H

prezzo su richiesta / price on request

10 03 B

Lastra AISI304 satinato - dimensioni e lavorazioni personalizzate
AISI304 satin plate - customised dimensions and machining

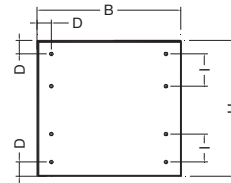

prezzo su richiesta / price on request

11 00

Numeri e lettere in AISI304 satinato con supporto

AISI304 satin numbers and letters with support

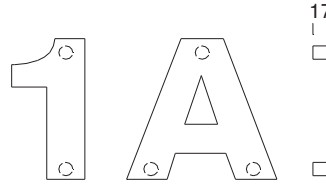

h. mm. 150x2
font: HELVETICA

NC150/

prezzo su richiesta / price on request

per ordini, aggiungere al codice sopra il nr. o la lettera scelta (es. nr. 1 codice NC150/1 - lettera A codice NC150/A)
to order, add the number or the letter chosen to the code above (es. nr. 1 code NC150/1 - letter A code NC150/A)

11 01

Numeri e lettere in AISI304 satinato senza supporto
(biadesivo o collante non incluso)

AISI304 satin numbers and letters without support
(double-sided tape or adhesive non included)



h. mm. 150x2
font: HELVETICA

NP150/

prezzo su richiesta / price on request

per ordini, aggiungere al codice sopra il nr. o la lettera scelta (es. nr. 1 codice NP50/1 - lettera A codice NP150/A)
to order, add the number or the letter chosen to the code above (es. nr. 1 code NC150/1 - letter A code NC150/A)

11 02

Numeri e lettere in AISI304 satinato con supporto

AISI304 satin numbers and letters with support

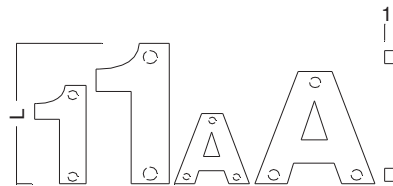

FONT e DIMENSIONI SU MISURA
CUSTOM FONTS e DIMENSIONS

prezzo su richiesta / price on request

per ordini, aggiungere al codice sopra il nr. o la lettera scelta (es. nr. 1 codice NC150/1 - lettera A codice NC150/A)
to order, add the number or the letter chosen to the code above (es. nr. 1 code NC150/1 - letter A code NC150/A)

11 03

Numeri e lettere in AISI304 satinato senza supporto
(biadesivo o collante non incluso)

AISI304 satin numbers and letters without support
(double-sided tape or adhesive non included)



FONT e DIMENSIONI SU MISURA
CUSTOM FONTS e DIMENSIONS

prezzo su richiesta / price on request

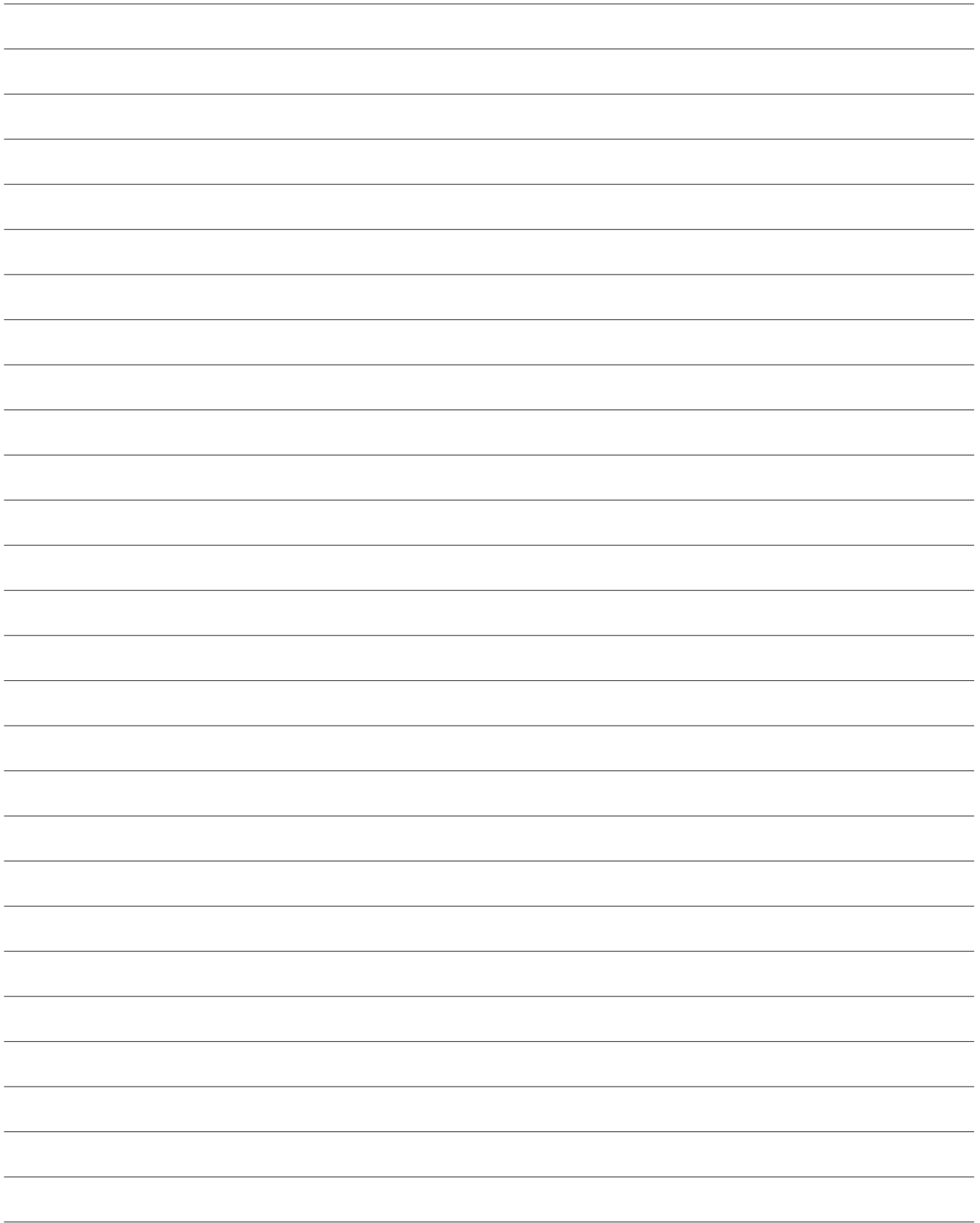

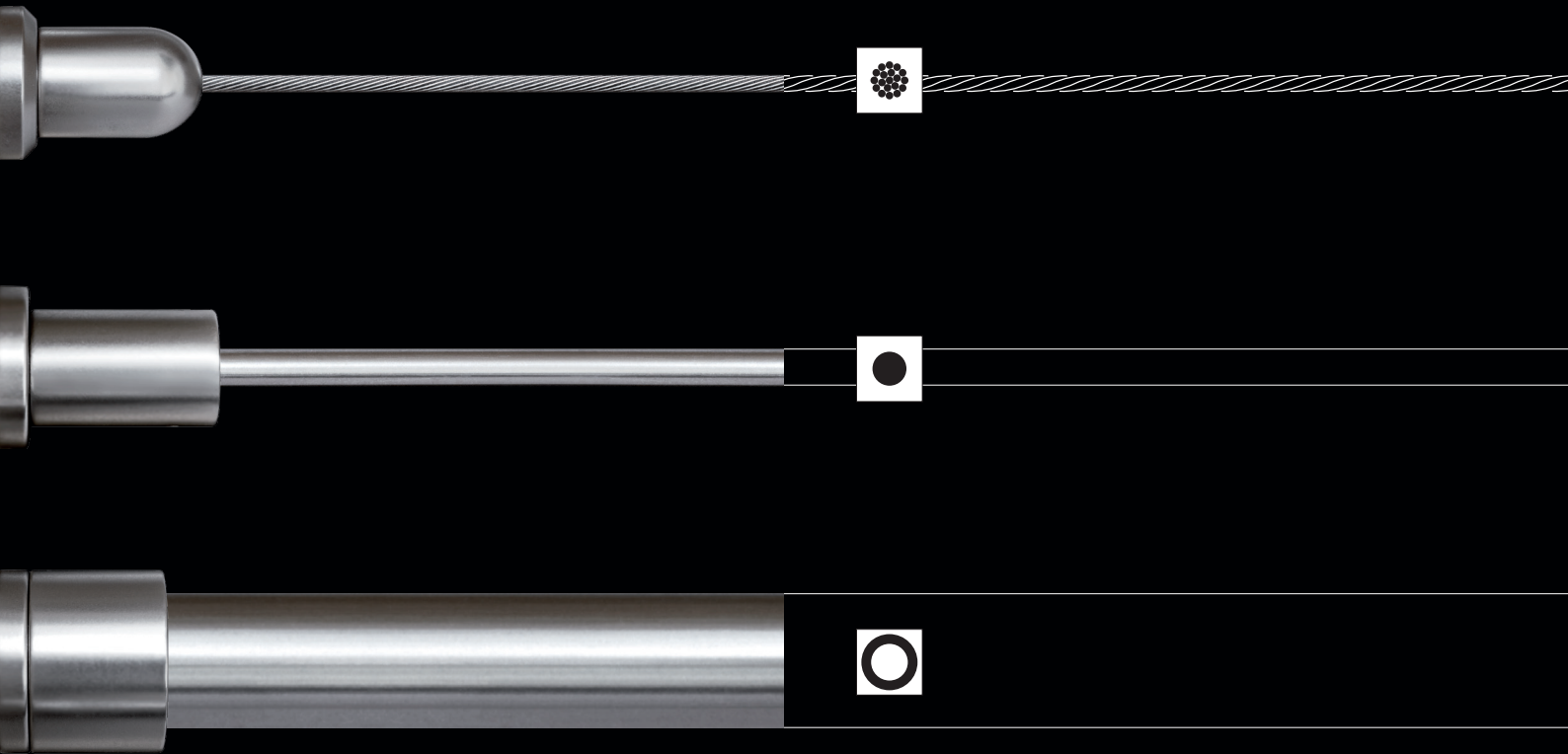

tahuma
Alternative Interior Decoration

www.tahuma.it / +39 0341 981535
tahuma@officina-colombo.com



tahuma è un marchio di
OFFICINA COLOMBO
TORNERIA AUTOMATICA DI PRECISIONE
OFFICINA COLOMBO s.r.l.
Via alle Prade, 10
23815 Introbio (LC) Italy
Cod.Fisc., P. IVA 01696470135

Rivenditore Qualificato - Qualified Dealer - Autorisierter Händler - Revendeur Qualifié